

# PIEZOCERAMIC SPEAKERS PIEZO AUDIO AMPLIFIERS

SCS Series

SPS Series

Blue line SPS Series

PAA Series

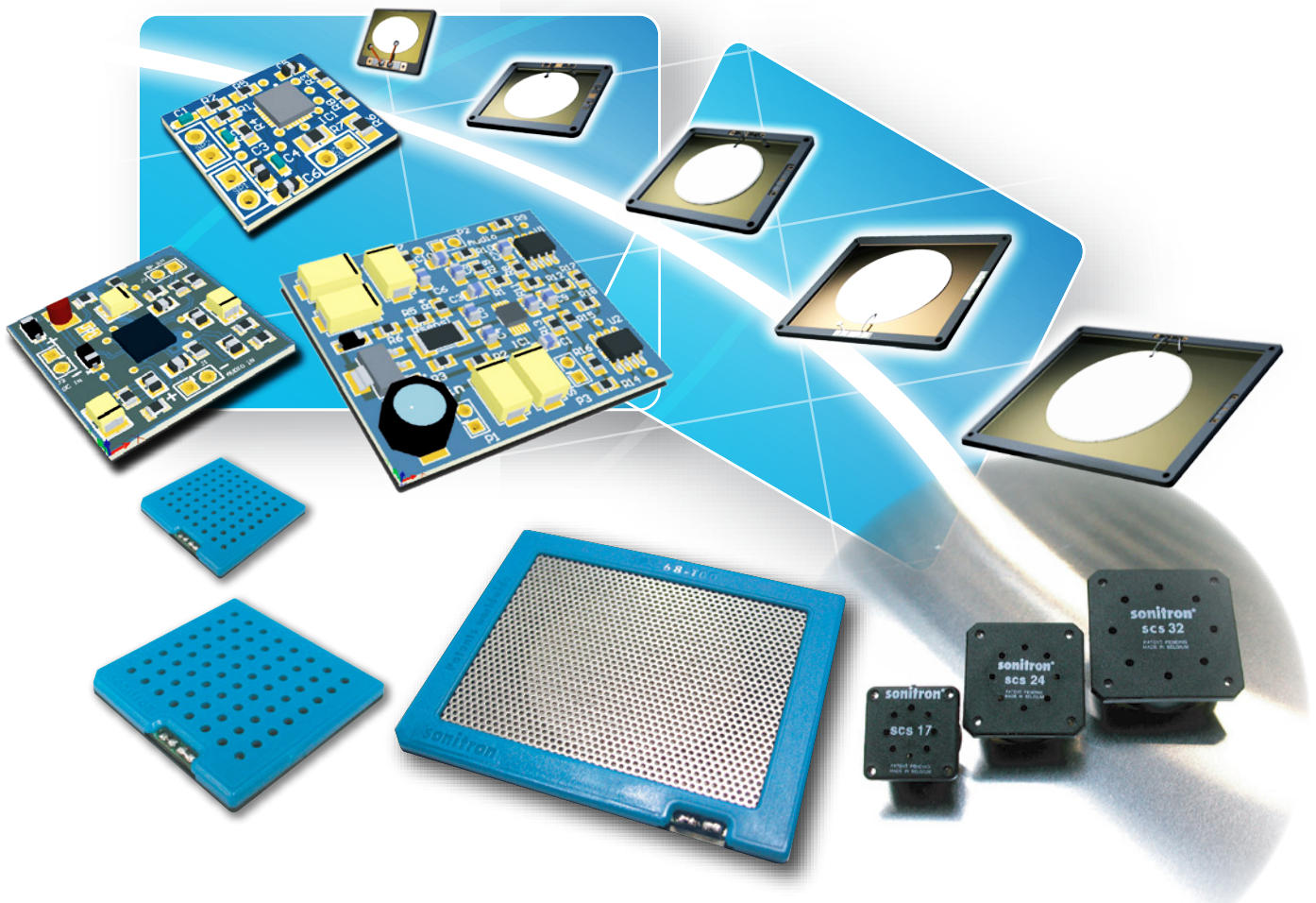

*SPS-Series: these are special speakers developed on special requests for OEM applications, modifications can be realized on dimensions, mounting, sound frequency, SPL, color, soldering method etc...*

*"Advanced Technology with smart materials such as piezoceramics offer many new applications in audible components and devices. This new technology is a continuous development work that will bring you to the forefront in this world."*

# KEY QUESTIONS FOR SPEAKER DETERMINATION

**1. Mounting method:**  
*glued, screws, pins, ultrasonic ?*

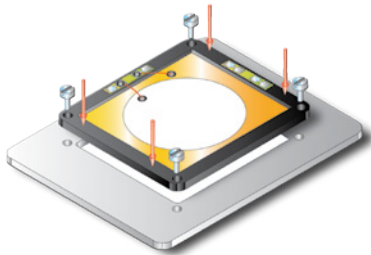

**2. Connection method:**  
*wires, pressure spring contacts, solder pads ?*

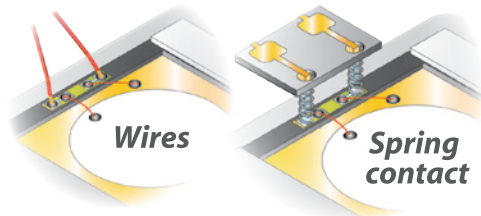

**3. Maximum dimensions (in mm):**  
*length, width, thickness ?*

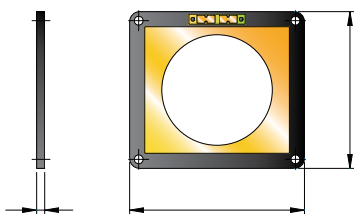

**4. Supply voltage:**  
*battery or mains supply ?*



**5. SPL – dB @ 1 meter ?**

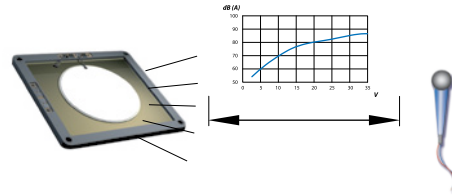

**6. Operating frequency range ?**

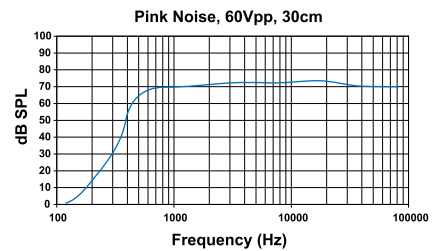

**7. Type of audio signal ?** *Speech, Music,...*



**8. Temperature range in °C ?**

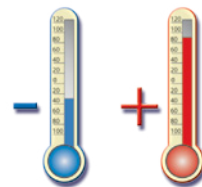

## GENERAL OVERVIEW SCS-SPS-BLUE LINE-PAA SERIES

Model	Frequency range	Max. SPL	Operating voltage
-------	-----------------	----------	-------------------

### SCS series



SCS-17	1500-8000	2200 Hz - 92 dB 5000 Hz - 91 dB	5 to 30 Vpp
SCS-24	1000-8000	800 Hz - 68 dB 1600 Hz - 95 dB 4000 Hz - 87 dB	5 to 30 Vpp
SCS-32	500-8000	650 Hz - 85 dB 2700 Hz - 100 dB 3700 Hz - 88 dB 7500 Hz - 80 dB	5 to 30 Vpp

Measurement MaxSPL in free air @ 30 cm, 30Vpp sine wave.

### SPS series

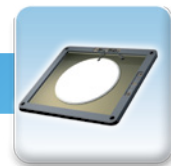

SPS-2220-03	700-20 kHz	85 dB*	1 to 24 Vpp
SPS-3530-03	700-20 kHz	81 dB	5 to 60 Vpp
SPS-4640-03	400-20 kHz	83 dB	5 to 60 Vpp
SPS-6555-03	300-20 kHz	83 dB	5 to 60 Vpp
SPS-8770-03	200-20 kHz	84 dB	5 to 60 Vpp

\*Measurement Max. SPL: average @ 4 points, @ 1m, 60Vpp. (SPS-2220-03 @ 10 cm, 24Vpp)

### Blue Line SPS series

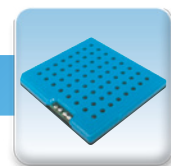

SPS-29-T00	1-20 kHz	86 dB*	5 to 60 Vpp
SPS-41-T00	450Hz-20 kHz	90 dB	5 to 60 Vpp
SPS-53-T00	300Hz-20 kHz	93 dB	5 to 60 Vpp
SPS-68-T00	250Hz-20 kHz	93 dB	5 to 60 Vpp

\*Measurement Max. SPL: average @ 4 points, @ 1m, 60Vpp.

### PAA series

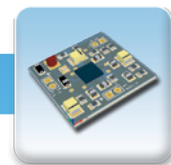

	Max. output voltage
PAA-LT3469-01	30 Vpp
PAA-MAX9788-01	20 Vpp
PAA-LM4960-02	24 Vpp
PAA-StepUpBTL-01	60 Vpp

## SCS SERIES (SONITRON Ceramic Speakers)



### INTRODUCTION

Introduced as the first models of Sonitron's piezoceramic speakers, the SCS-series are still being used for numerous applications.

Good sound quality and limited distortion guarantee a clear reproduction of multiple tones, speech and music. The piezo speaker has 60% more net sound output per membrane surface than the electro-dynamic speaker in function of the average current drain and average sound pressure level. These loudspeakers are extremely reliable, have a robust design and can be used in difficult environmental conditions and applications because of resistance of the front to water, humidity, vibrations and dust.

The SCS-speaker can be mounted by soldering the SMD pads onto the PCB.

For a pin-version, the pins can be soldered onto the PCB. Extra stability against vibration is achieved by screwing the housing onto the application.

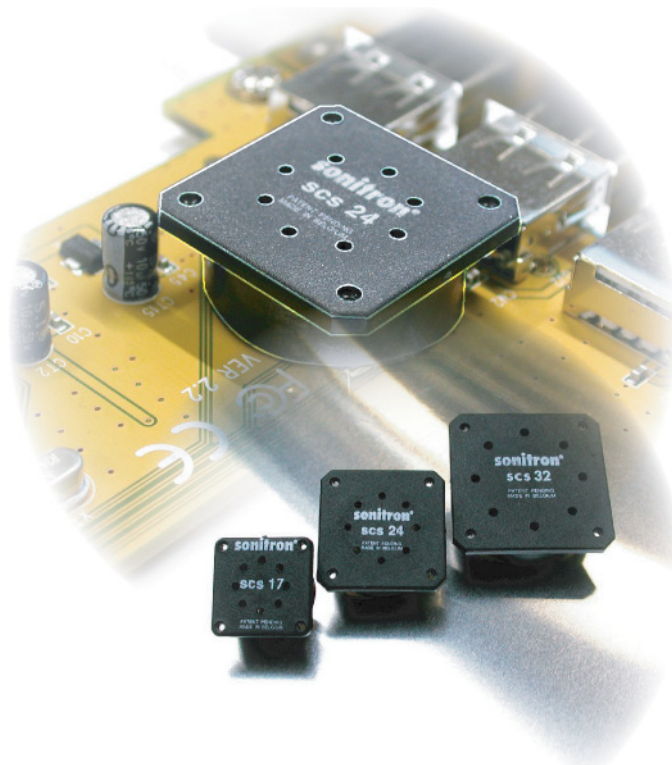

## GENERAL OVERVIEW SCS-SERIES

Model	Frequency range	Peak frequency SPL	Operating voltage
SCS-17	1500 - 8000 Hz	2200 Hz - 92 dB 5000 Hz - 91 dB	5 to 30 Vpp
SCS-24	1000 - 8000 Hz	800 Hz - 68 dB 1600 Hz - 95 dB 4000 Hz - 87 dB	5 to 30 Vpp
SCS-32	500 - 8000 Hz	650 Hz - 85 dB 2700 Hz - 100 dB 3700 Hz - 88 dB 7500 Hz - 80 dB	5 to 30 Vpp



## ADVANTAGES & APPLICATIONS

### ADVANTAGES:

- very flat and solid construction
- dust, water- and shockproof front panel
- resistant to temperature variations
- broad frequency range in small size
- combined use as speaker/microphone
- no electromagnetic field (EMC)
- little energy required at low frequencies
- less current consumption needed in the leads to the speaker
- 60% higher acoustic output in smaller speakers compared to electrodynamic speakers
- low weight
- high impedance
- can be driven directly by IC

### APPLICATIONS:

- home equipment & domotics
- communication equipment
- home monitoring equipment
- talking buzzer & door bell
- computer equipment
- vending machines
- electronic wheelchair
- medical equipment
- multimedia equipment
- industrial equipment
- flight instrumentation
- portable voice recorders
- paging systems
- instrumentation

## SPECIFICATIONS

Operating temperature:	-40°C to +85°C
Storage temperature:	-40°C to +85°C
Case material:	PBT (UL rating: 94 HB) for pin-versions), PPS (UL rating: 94 V0/5V) for SMD-versions)
Standard colour of case:	Black

Model	Frequency range	Peak frequency SPL	Capacitance ±20%	Operating voltage	Impedance @ 1KHz ±20%	Weight
SCS-17	1500 - 8000 Hz	2200 Hz - 92 dB 5000 Hz - 91 dB	20 nF	5 to 30 Vpp	7957 ohm	1.7 g
SCS-24	1000 - 8000 Hz	800 Hz - 68 dB 1600 Hz - 95 dB 4000 Hz - 87 dB	37 nF	5 to 30 Vpp	4300 ohm	4 g
SCS-32	500 - 8000 Hz	650 Hz - 85 dB 2700 Hz - 100 dB 3700 Hz - 88 dB 7500 Hz - 80 dB	66 nF	5 to 30 Vpp	2400 ohm	5.9 g

All measurements are made in free air @30 cm using a 30 Vpp sine wave.  
The speakers were mounted in a box with dimensions 40x15x5 cm.

## IMPEDANCE

Theoretical the main impedance of the piezo speakers is a capacitive reactance and follows an asymptotic function.

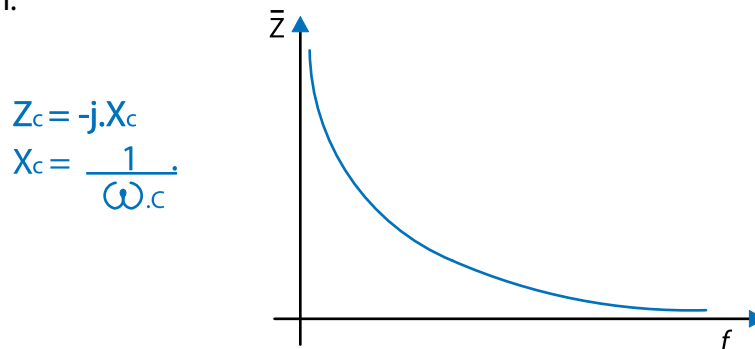

The typical practical impedance values (± 20%) for frequencies of 100 Hz up to 20 kHz of our speakers are as follows:

Model	SCS-17	SCS-24	SCS-32
Capacitance (±20%)	20 nF	37 nF	66 nF
Z (0.1 kHz)	79577 ohm	43000 ohm	24114 ohm
Z (1 kHz)	7957 ohm	4300 ohm	2411 ohm
Z (2 kHz)	3978 ohm	2150 ohm	1205 ohm
Z (5 kHz)	1591 ohm	860 ohm	482 ohm
Z (10 kHz)	795 ohm	430 ohm	241 ohm
Z (15 kHz)	530 ohm	286 ohm	161 ohm
Z (20 kHz)	397 ohm	215 ohm	121 ohm

## FREQUENCY RESPONSE

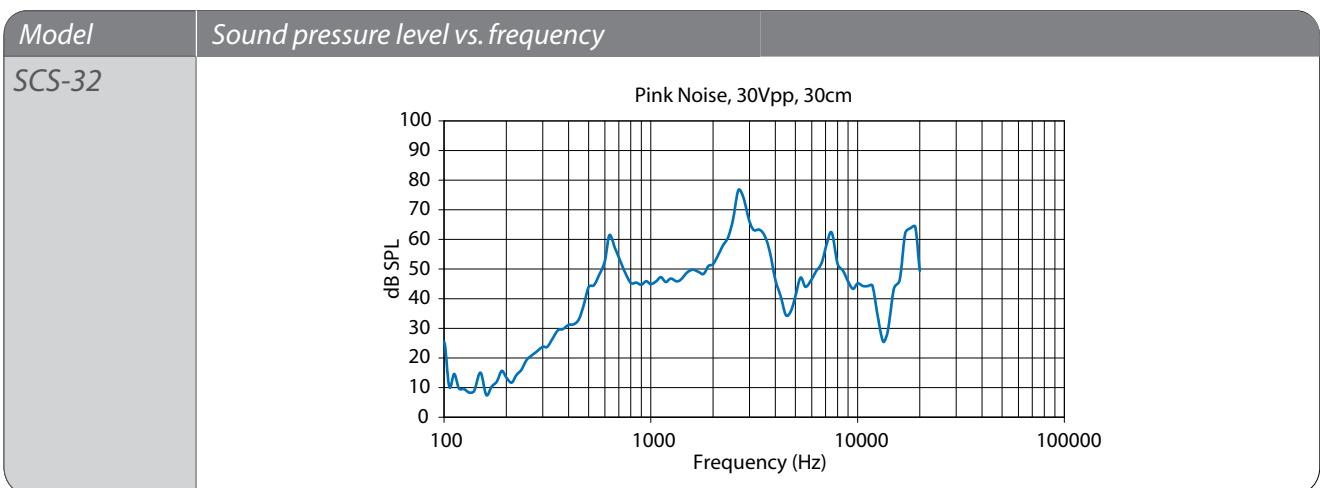
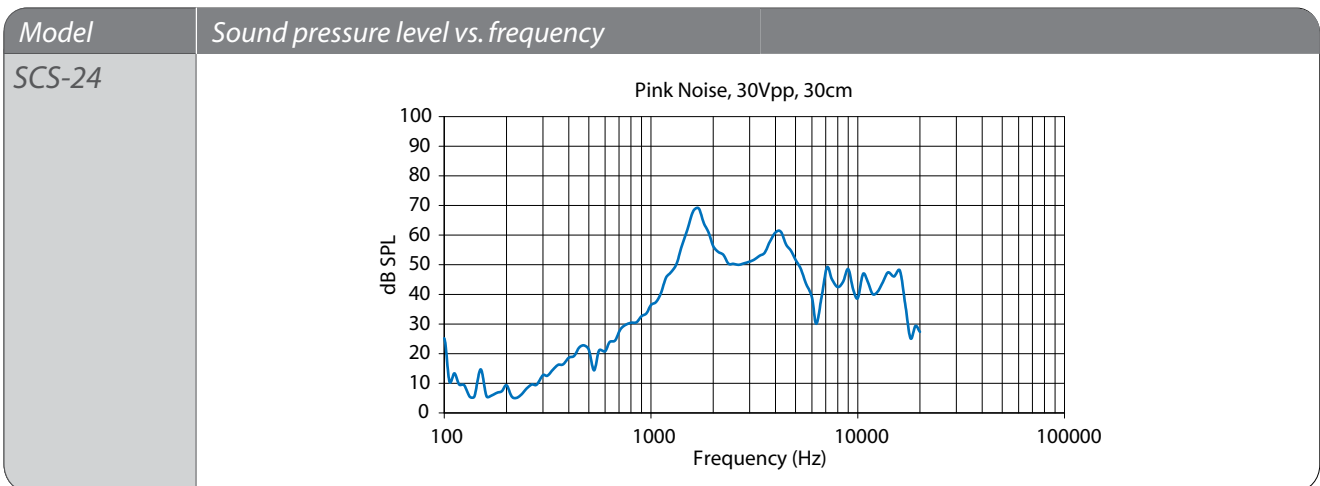
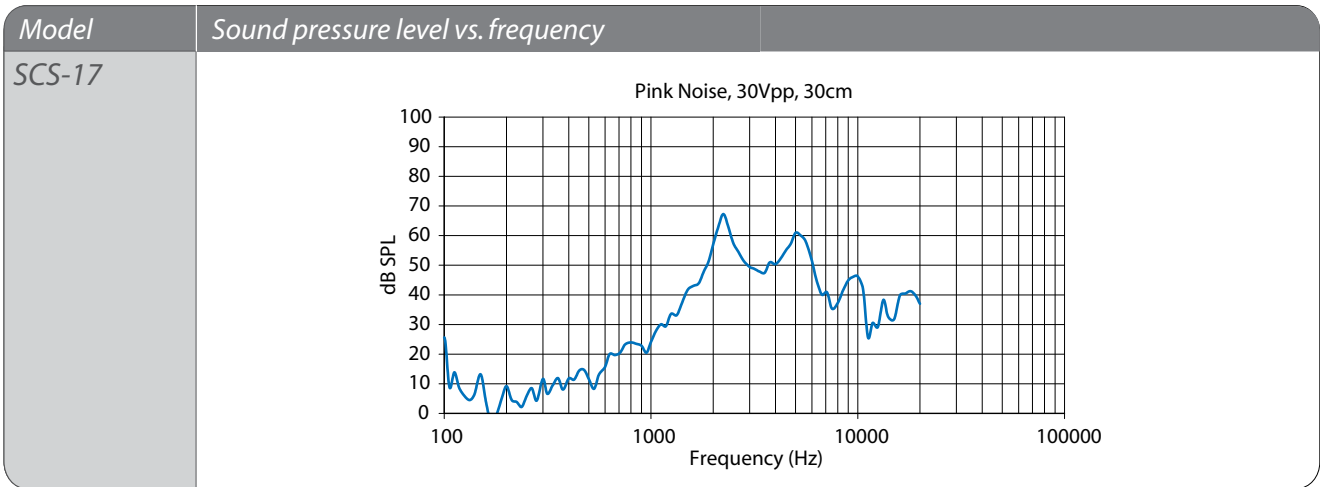

Pink noise measurements made in free air.  
 The speakers were mounted in a box with dimensions 40x15x5 cm.

**DIMENSIONS** (All dimensions are in mm)

**SCS-17-P10**

**Pin-version**  
(case in PBT)

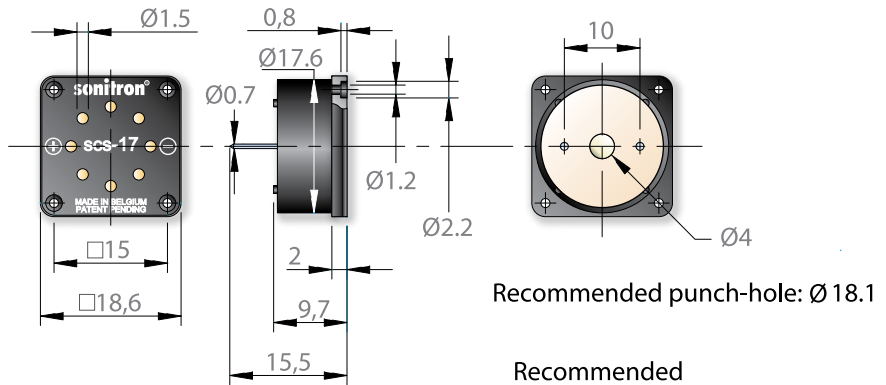

**SCS-17-S**

**SMD-version**  
(case in PPS)

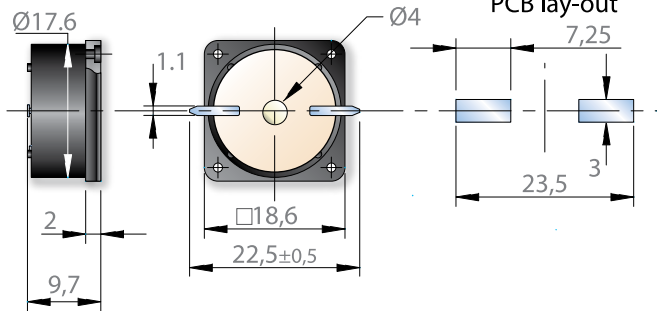

**SCS-24-P10**

**Pin-version**  
(case in PBT)

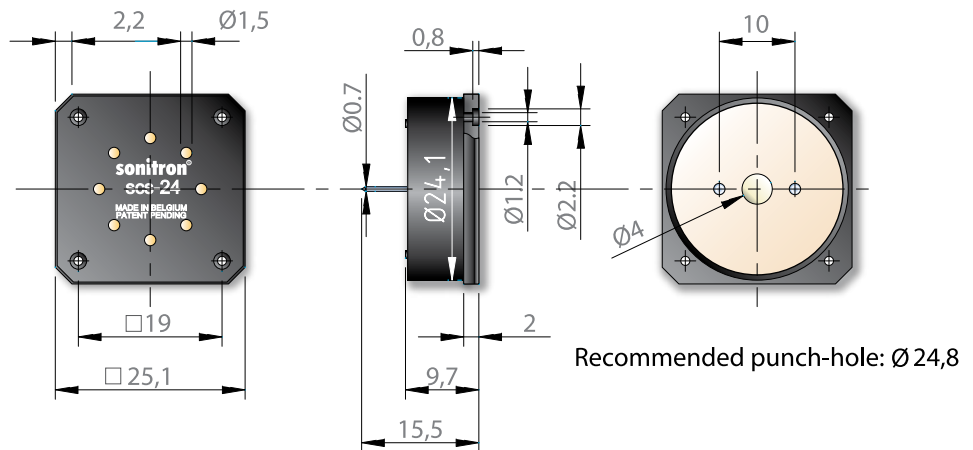

**SCS-24-S**

**SMD-version**  
(case in PPS)

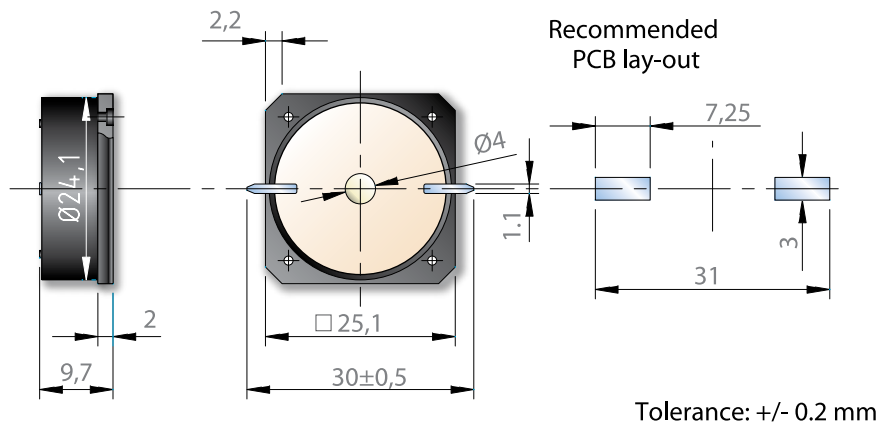



## DIMENSIONS (All dimensions are in mm)

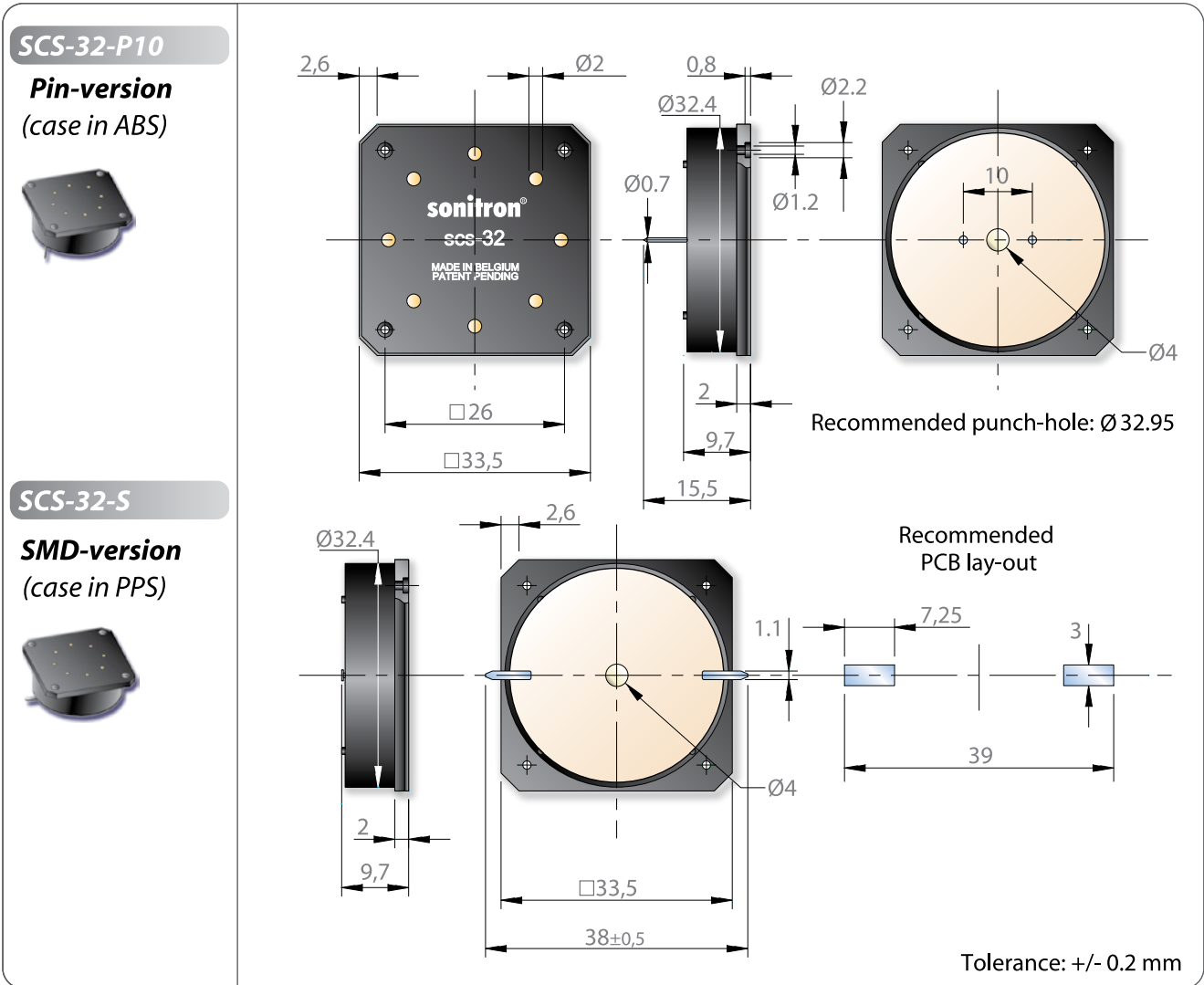

## PRODUCT OPTIONS

Option Code	example	Description
<b>SP02</b>	SCS-32-P10/ <b>SP02</b>	Contains heavy duty wires (plastic insulation), connection sealed with silicone.
<b>FP17S</b>	SCS-24-S- <b>FP</b>	Acoustic stabilization Foam Patch, easy to stick. For: SCS-24-P10 SCS-24-S
<b>FP24S</b>	SCS-32-S- <b>FP</b>	Acoustic stabilization Foam Patch, easy to stick. For: SCS-32-P10 SCS-32-S

## Recommended Piezo Audio Amplifiers

**Sonitron production models**

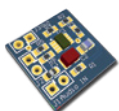

PAA-LT3469-01

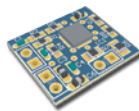

PAA-MAX-9788-01

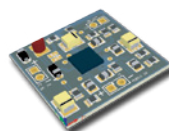

PAA-LM4960SQ-02

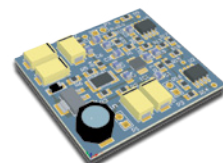

PAA-StepUpBTL-01

## PRODUCT CODIFICATION

SCS ↓ Sonitron Ceramic Speaker	SCS-17 SCS-24 SCS-32 ↓ Square diameter (mm)	P S ↓ P: Pin distance (mm) S: SMD-connection
--------------------------------------------	---------------------------------------------------------	----------------------------------------------------------

## LIST OF AVAILABLE PRODUCT TYPES

SCS-17-P10 SCS-17-S	SCS-24-P10 SCS-24-S	SCS-32-P10 SCS-32-S
------------------------	------------------------	------------------------

## PACKAGING

All speakers with through hole pins, are packed on a polystyrene board (245 L x 245 W) and sold in boxes with dimensions of 250 L x 250 W x 125 H.

Number	SCS-17 P10	SCS-24 P10	SCS-32 P10
per board	100	81	49
per box	(5x100) 500	(5x81) 405	(5x49) 245

All SMD models are packed in trays (245 L x 245 W) and sold in boxes with dimensions of 250 L x 250 W x 125 H.

Number	SCS-17-S	SCS-24-S	SCS-32-S
per board	49	42	25
per box	(7x49) 343	(5x42) 210	(6x25) 150

Dimensions of the tray and position of the SMD components of the models SCS-17-S, SCS-24-S and SCS-32-S are illustrated below:

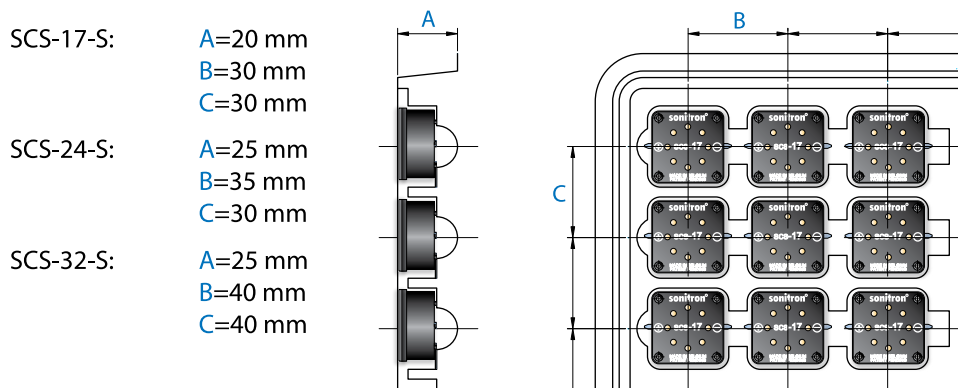

## ACOUSTIC MOUNTING INSTRUCTIONS FOR SCS-SPEAKERS

- Fundamental mounting recommendations see page 110.
- The SCS speakers can be mounted in several different ways. The recommended mounting methods illustrated below are the best ways to mount all the SCS speaker models.

**Soldered with pins on the PCB**

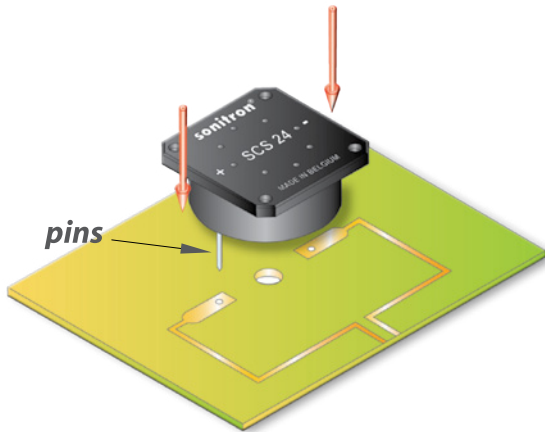

**SMD soldered on the PCB**

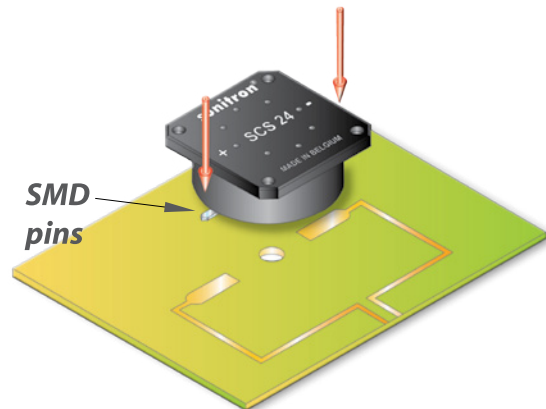

**Panel mounting, secured with 4 screws**

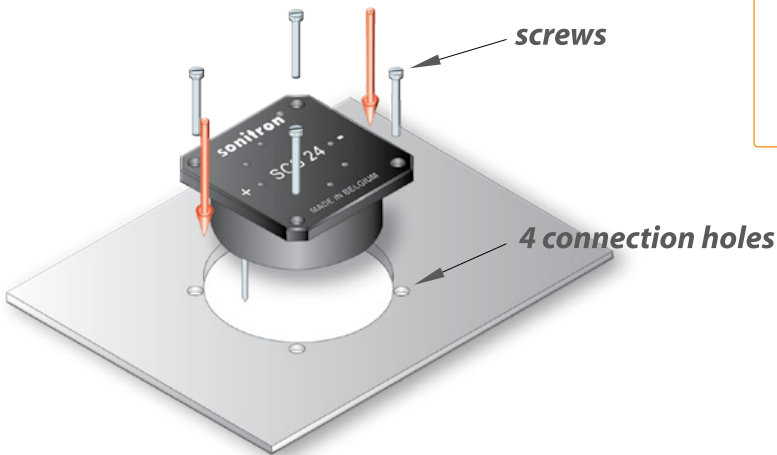

**Product Options available:**

- SP02
  - Foam Patch FP
- (see page 132)

When mounted on a PC-board, a central hole in the PC-board of minimum 5 mm diameter is recommended.

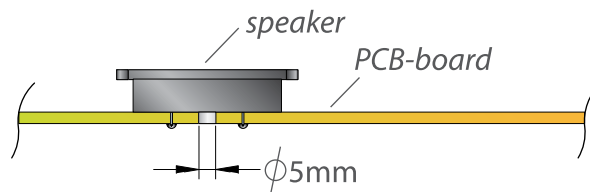

**Other methods...**

## SPS SERIES (SONITRON Polymer/metal Speakers)



### INTRODUCTION

Based on the in-house expertise in vibration characteristics of piezoceramic material and micro-acoustics, Sonitron successfully developed the SPS-series piezoceramic speakers for industrial, multimedia and automotive applications. The SPS-series is based on a completely new principle of piezoceramics and a composite polymer/metal membrane. The composite polymer/metal membrane reduces unwanted resonance peaks to provide a more even frequency response than can be achieved with conventional designs. High sound quality and low distortion guarantee perfect reproduction of music and speech.

Piezoceramic speakers offer a faster response than conventional magnet speakers because of their lower mass (no voice coil). Magnet speakers are less efficient than piezo speakers because of the losses via the voice coil. Piezoceramic speakers also feature a low weight and low energy consumption relative to their sound output levels. They do not generate an electromagnetic field, making it easier for designers to ensure that their products meet EMC requirements and regulations.

Sonitron's SPS speakers have a very flat design and are delivered with an open front. They can be used in difficult environmental conditions and applications because of resistance of the front to water, humidity, vibrations and dust.

The described models are released for applications such as mobile phone, PDA, flat LCD computer screens and computer monitors, consumer products, car audio, instrumentation, portable devices, public address systems, paging systems, etc.

#### SPS Series

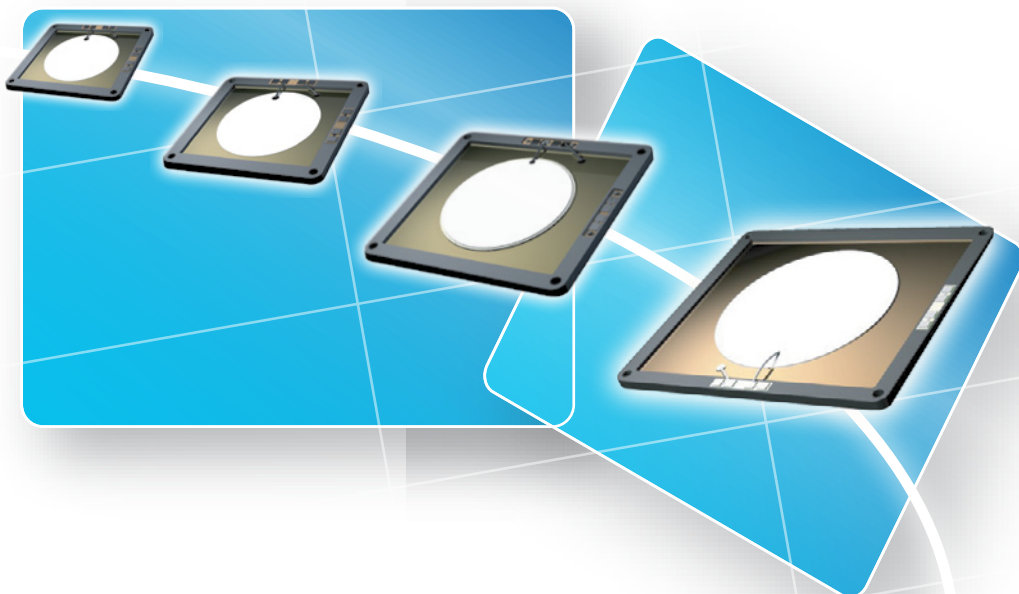

## ADVANTAGES & APPLICATIONS

### ADVANTAGES :

- very flat and solid construction
- dust, water- and shockproof
- resistant to temperature variations
- broad frequency range in small size
- combined use as speaker/micro
- no electro-magnetic field (EMC)
- little energy required at low frequencies
- less current consumption needed in the leads to the speaker
- 60% higher acoustic output for smaller speakers compared to electrodynamic speakers
- low weight
- low distortion
- high impedance
- can be driven directly by IC

### APPLICATIONS :

- home equipment & domotics
- communication equipment
- talking buzzer & door bell
- computer equipment
- cars, busses and trains
- vending machines
- multimedia equipment
- industrial equipment
- portable voice recorders
- paging systems
- public address systems
- instrumentation
- mobile phone
- car audio system

## SPECIFICATIONS

Model	Operating voltage (Vac pp)	Frequency range (Hz)	Max. SPL dB @ 1m, average 4 points	Applications	Capacitive load	Dimensions mm (LxWxH)
SPS-2220-03	1-24	700-20000	85*	GSM, GPS, MP3, camera,...	70nF	22x20x2
SPS-3530-03	5-60	700-20000	81	PDA, GPS, notebooks,...	220nF	43.5x39x2
SPS-4640-03	5-60	400-20000	83	PDA, GPS, notebooks,...	225nF	50x43.6x2
SPS-6555-03	5-60	300-20000	83	Multimedia,...	480nF	65x55x2
SPS-8770-03	5-60	200-20000	84	Computers,...	580nF	87x70x2

\*@10 cm, designed for headphone applications!

## IMPEDANCE

Theoretical the main impedance of the piezo speakers is a capacitive reactance and follows an asymptotic function.

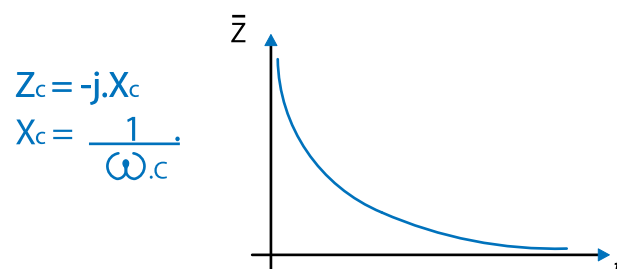

The typical practical impedance values ( $\pm 20\%$ ) for frequencies of 100 Hz up to 20 kHz of our speakers are as follows:

Model	SPS-2220-03	SPS-3530-03	SPS-4640-03	SPS-6555-03	SPS-8770-03
Capacitance ( $\pm 20\%$ )	70 nF	220 nF	225 nF	480 nF	580 nF
Z @ 100 Hz	22360 ohm	5714 ohm	6210 ohm	3845 ohm	2314 ohm
Z @ 1 kHz	2162 ohm	603 ohm	680 ohm	445 ohm	266 ohm
Z @ 2 kHz	1183 ohm	311 ohm	360 ohm	223 ohm	133 ohm
Z @ 5 kHz	497 ohm	127 ohm	143 ohm	92 ohm	54 ohm
Z @ 10 kHz	245 ohm	65 ohm	73 ohm	45 ohm	28 ohm
Z @ 15 kHz	168 ohm	43 ohm	49 ohm	31 ohm	19 ohm
Z @ 20 kHz	125 ohm	32 ohm	37 ohm	23 ohm	14 ohm

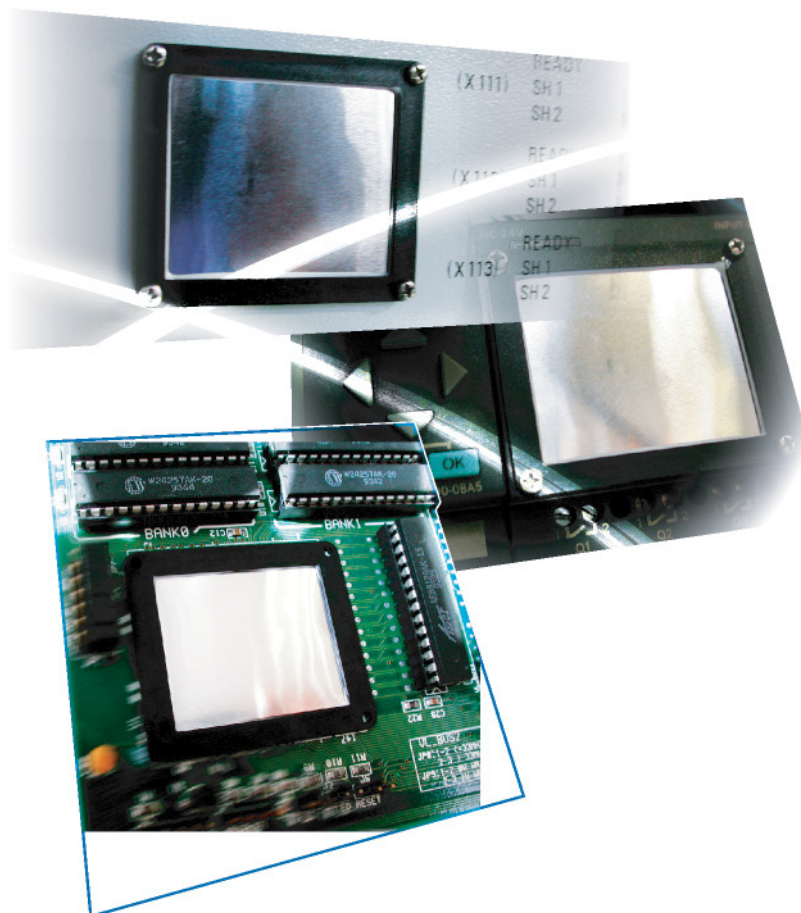

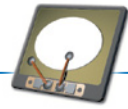

## SPS-2220-03



Sonitron's latest slim line profile speaker, the SPS-2220-03, is the result of ten years intensive research and development work. With a thickness of only 1 mm and dimensions of 20x22 mm, this small multifunctional speaker/microphone is ideal for use in GPS, MP3, camera's, mobile phones,... It is distortion free and has excellent sound reproduction. Considering its extremely good voice clarity it definitely is the new speaker generation for the mobile phone industry.

## SPECIFICATIONS

Frequency Range :	700 Hz-20 kHz
Max SPL @ 10 cm, 24Vpp: (average at 4-point)	85 dB
Distortion (%THD): (80dB @ 5 cm, average @ 4-point)	≤1%
Sensitivity: (SPL @ 10cm for 1Vrms, average at 4-point : 800Hz, 1kHz, 1.5kHz, 2kHz)	63 dB
Capacitance (+/- 20%):	70 nF
Impedance @ 1kHz (+/-20%):	2.16 kohm
Operating Voltage:	1Vpp-24Vpp
Weight:	0.4g
Operating Temperature:	-20°C to 60°C
Storage Temperature:	-40°C to 60°C
Case material:	PC
Standard color:	Black

speaker mounted on plexi plate of 5 x 5cm in closed box of 40 x 15 x 5cm

## FREQUENCY RESPONSE

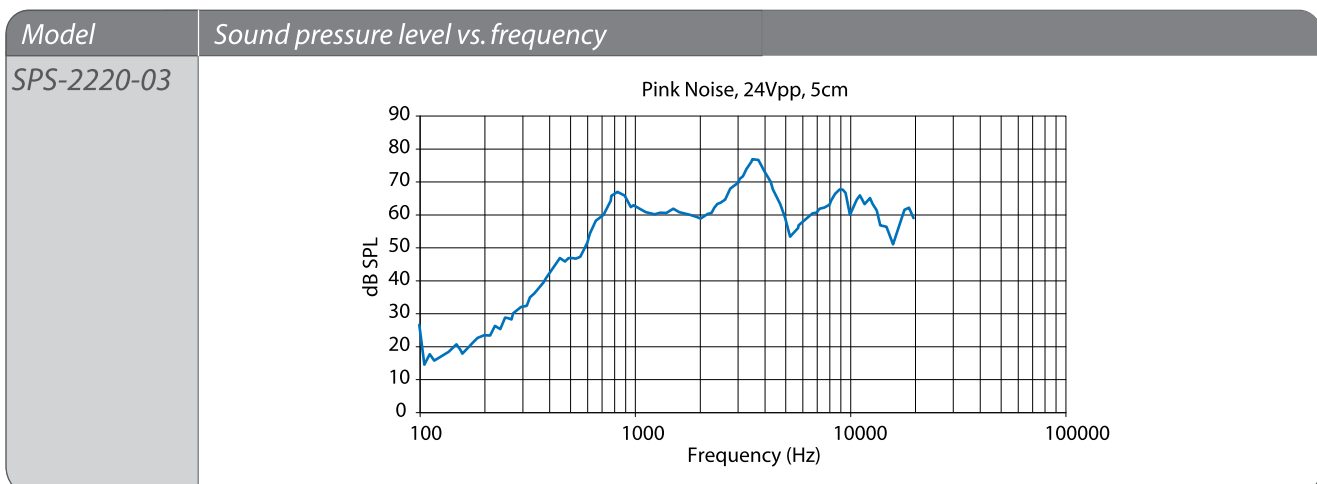

**DIMENSIONS** (all dimensions are in mm)

**SPS-2220-03**

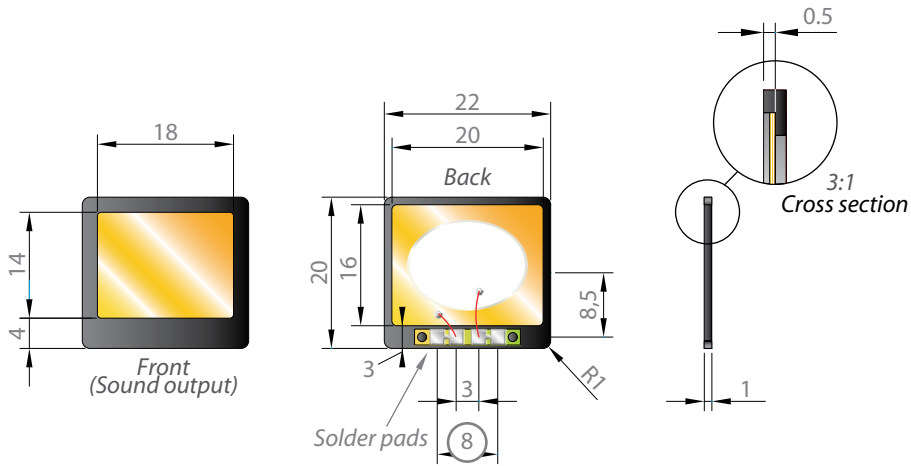

Tolerance: +/- 0.2mm mm

**Recommended Piezo Audio Amplifiers**

**Integrated Circuits**

**Maxim**  
MAX9788

**Texas Instruments**  
TPA2100P1

**Linear technology**  
LT3469

**Sonitron production models**

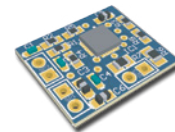

PAA-MAX-9788-01

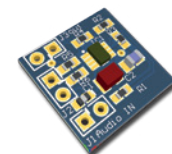

PAA-LT3469-01



## SPS-3530-03

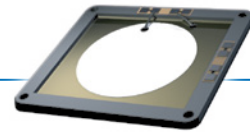

The electronics industry still is a very demanding industry which requires more and more flat and small components. Therefore Sonitron developed this new flat piezoceramic speaker. With a thickness of only 2 mm and dimensions of 39x43.5 mm, this small multifunctional speaker/microphone is ideal for use in portable electronic devices (PDA, GPS, MP3,...), notebooks and consumer products.

## SPECIFICATIONS

Frequency Range :	700 Hz - 20 kHz
Max SPL @ 1 m, 60 Vpp: (average at 4-point)	81 dB
Distortion (%THD): (80dB @ 5 cm, average @ 4-point)	≤1.5%
Sensitivity: (SPL @ 10cm for 1Vrms, average @ 4-point : 800Hz, 1kHz, 1.5kHz, 2kHz)	73 dB
Capacitance (+/- 20%):	220 nF
Impedance @ 1kHz (+/-20%):	603 ohm
Operating Voltage:	5-60 Vpp
Weight:	2.4g
Operating Temperature:	-20°C to 60°C
Storage Temperature:	-40°C to 60°C
Case material:	PC
Standard color:	Black

speaker mounted in closed box of 40 x 15 x 5cm

## FREQUENCY RESPONSE

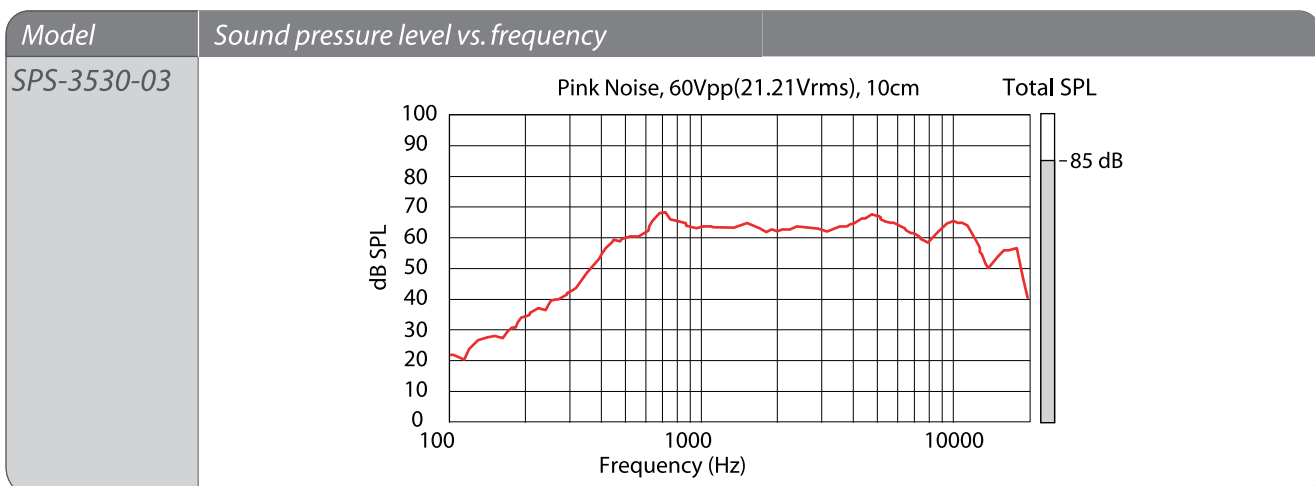

**DIMENSIONS** (all dimensions are in mm)

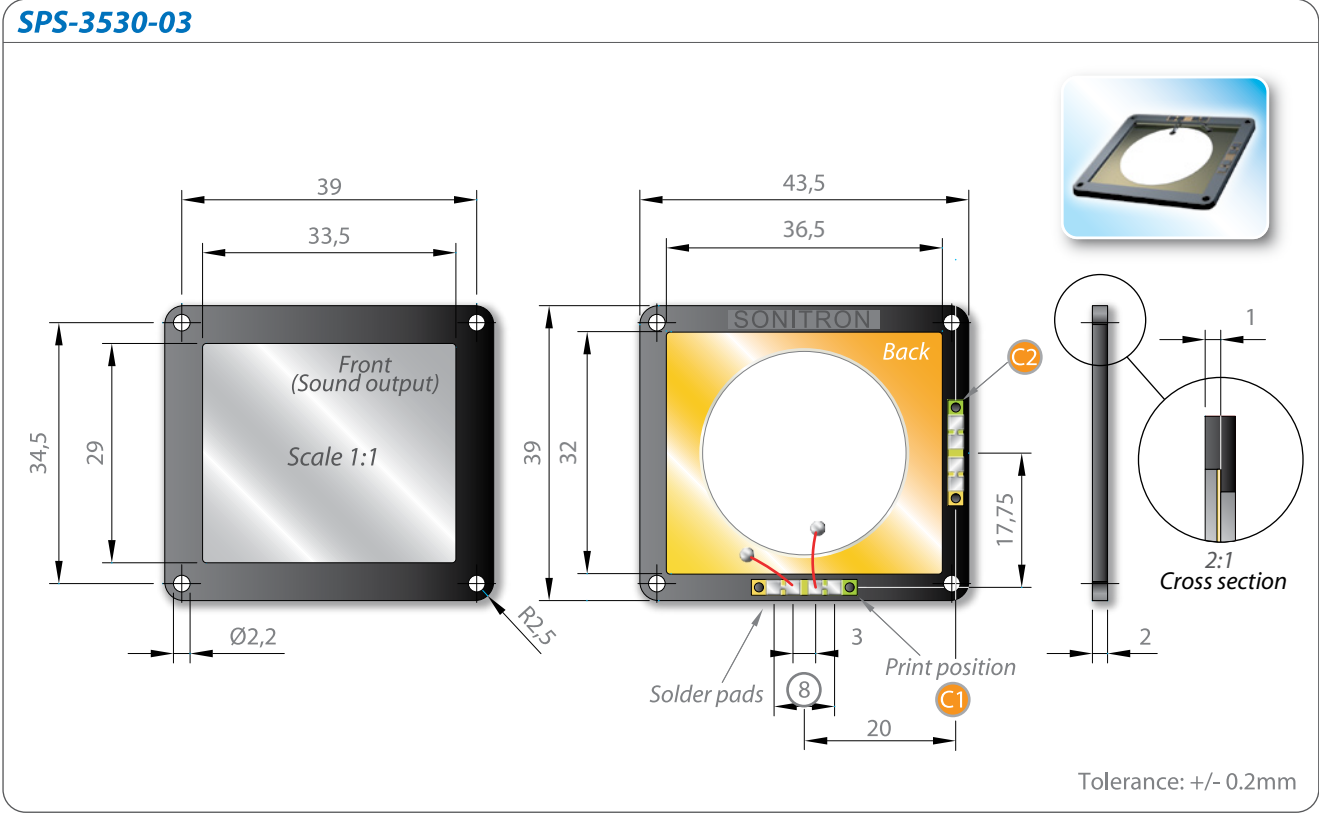

**Recommended Piezo Audio Amplifiers** (see page 104, 105, 106)

**Integrated Circuits**

**Maxim**  
MAX9788

**National semiconductor**  
LM4960

**Texas Instruments**  
TPA2100P1

**Sonitron production models**

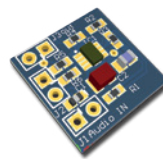

PAA-LT3469-01

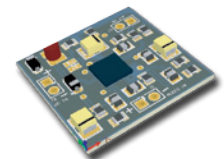

PAA-LM4960SQ-02

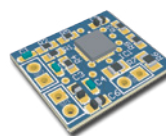

PAA-MAX-9788-01

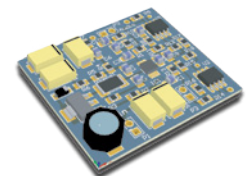

PAA-StepUpBTL-01

## SPS-4640-03

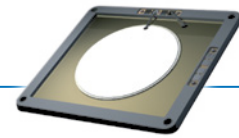

The electronics industry still is a very demanding industry which requires more and more flat and small components. Therefore Sonitron developed this new flat piezoceramic speaker. With a thickness of only 2 mm and dimensions of 43.6x50 mm this small multifunctional speaker/microphone is ideal for use in portable electronic devices (PDA, GPS, MP3,...), notebooks and consumer products.

## SPECIFICATIONS

Frequency Range :	400 Hz - 20 kHz
Max SPL @ 1 m, 60 Vpp: (average @ 4-point)	83 dB
Distortion (%THD): (80dB @ 5 cm, average @ 4-point)	≤1.5%
Sensitivity: (SPL @ 10cm for 1Vrms, average @ 4-point : 800Hz, 1kHz, 1.5kHz, 2kHz)	72 dB
Capacitance (+/- 20%):	225 nF
Impedance @ 1kHz (+/-20%):	680 ohm
Operating Voltage:	5-60 Vpp
Weight:	2.8g
Operating Temperature:	-20°C to 60°C
Storage Temperature:	-40°C to 60°C
Case material:	PC
Standard color:	Black

speaker mounted in closed box of 40 x 15 x 5cm

## FREQUENCY RESPONSE

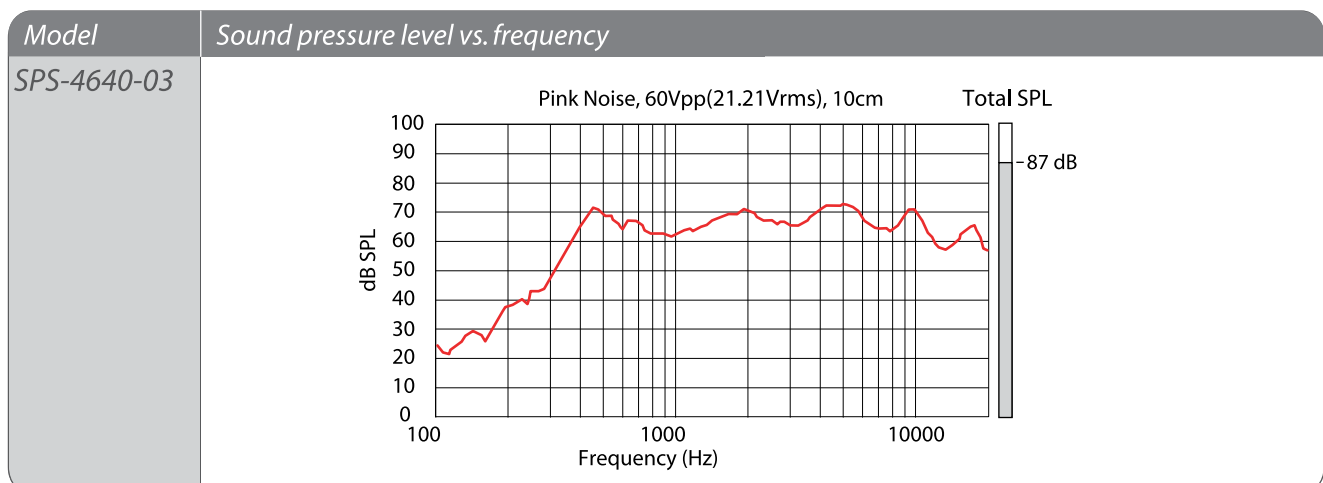



## SPS-6555-03



The new SPS-6555-03 is designed for applications where the space is limited and a high sound quality is required. This new speaker model features a broad frequency range combined with small dimensions which makes them ideal for multimedia applications.

### SPECIFICATIONS

Frequency Range :	300 Hz - 20 kHz
Max SPL @ 1 m, 60 Vpp: (average @ 4-point)	83 dB
Distortion (%THD): (80dB @ 1m, average @ 4-point)	≤1.5%
Sensitivity: (SPL @ 10cm for 1Vrms, average @ 4-point : 800Hz, 1kHz, 1.5kHz, 2kHz)	73 dB
Capacitance (+/- 20%):	480 nF
Impedance @ 1kHz (+/-20%):	333 ohm
Operating Voltage:	5-60 Vpp
Weight:	5g
Operating Temperature:	-20°C to 60°C
Storage Temperature:	-40°C to 60°C
Case material:	PC
Standard color:	Black

speaker mounted in closed box of 40 x 15 x 5cm

### FREQUENCY RESPONSE

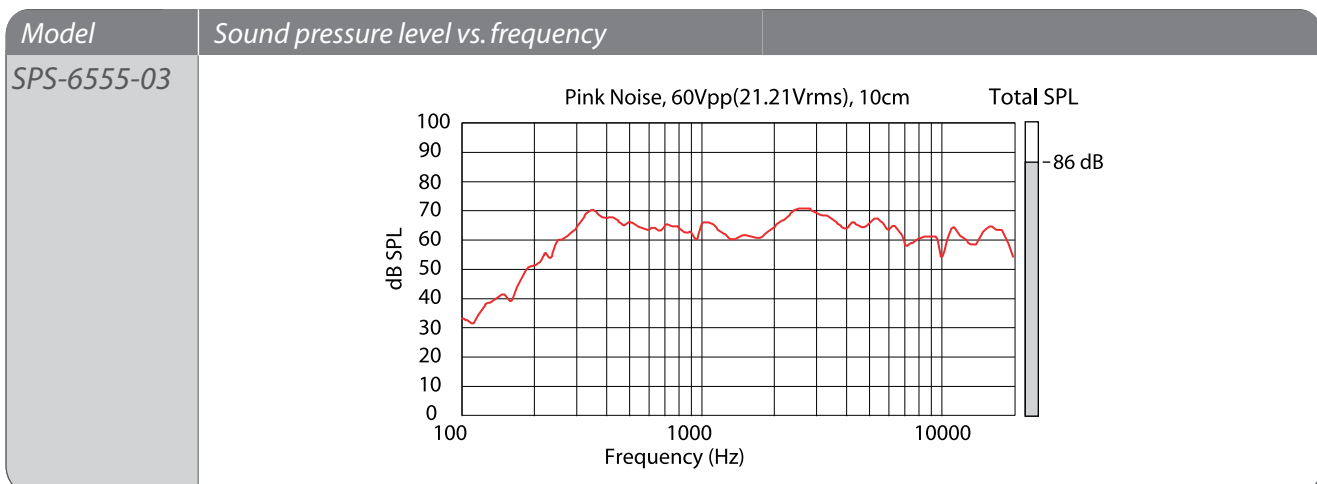



## SPS-8770-03

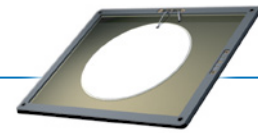

The SPS-8770-03 is the largest version of our piezo speakers, with a thickness of only 2 mm. This model is extremely suitable for flat devices when high sound output and broad frequency range are required. Low weight and easy mounting requirements are the extreme advantages of this speaker. Compared with conventional designs the speaker also has less current consumption.

## SPECIFICATIONS

Frequency Range :	200 Hz - 20 kHz
Max SPL @ 1 m, 60 Vpp: (average @ 4-point)	84 dB
Distortion (%THD): (80dB @ 5 cm, average @ 4-point)	≤1.5%
Sensitivity: (SPL @ 10cm for 1Vrms, average @ 4-point : 800Hz, 1kHz, 1.5kHz, 2kHz)	74 dB
Capacitance (+/- 20%):	580 nF
Impedance @ 1kHz (+/-20%):	266 ohm
Operating Voltage:	5-60 Vpp
Weight:	7.3g
Operating Temperature:	-20°C to 60°C
Storage Temperature:	-40°C to 60°C
Case material:	PC
Standard color:	Black

speaker mounted in closed box of 40 x 15 x 5cm

## FREQUENCY RESPONSE

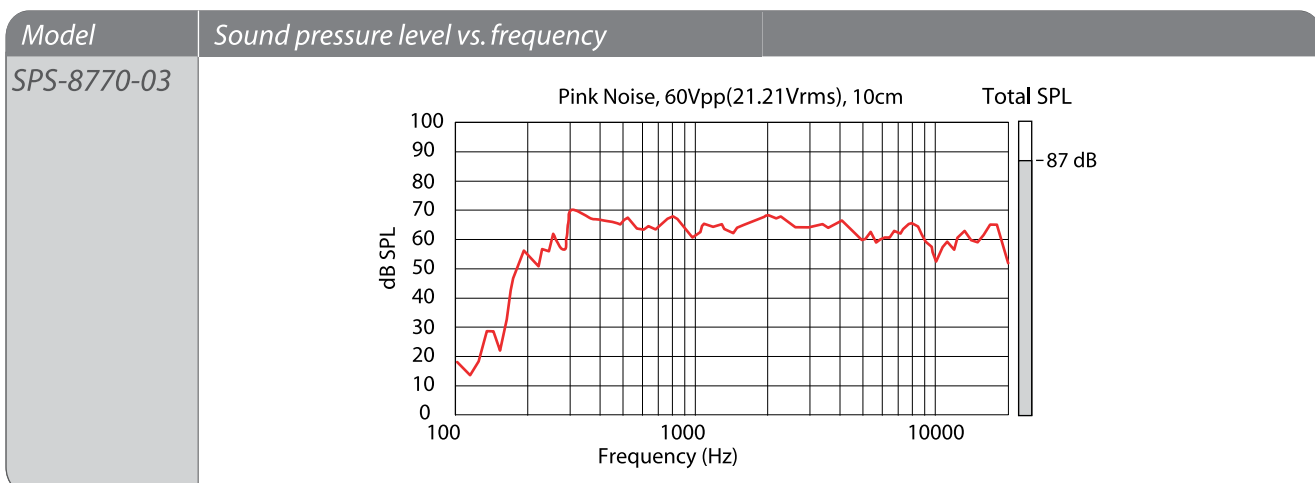

**DIMENSIONS** (all dimensions are in mm)

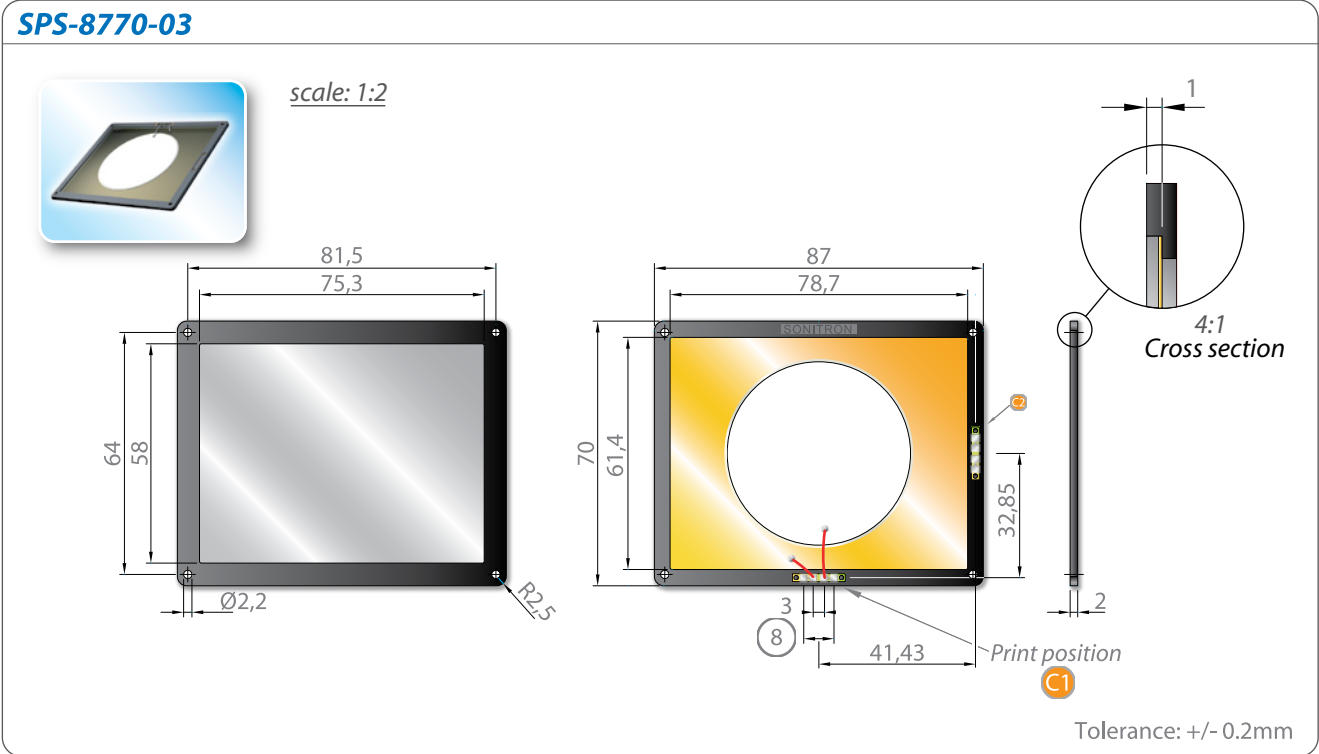

**Recommended Piezo Audio Amplifiers** (see page 104, 105, 106)

**Integrated Circuits**

**Maxim**  
MAX9788

**National semiconductor**  
LM4960

**Texas Instruments**  
TPA2100P1

**Sonitron production models**

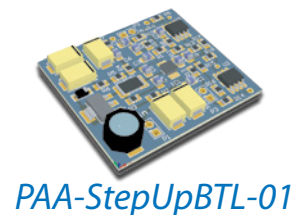
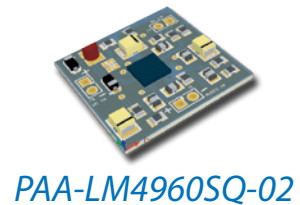
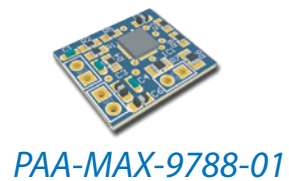



## PRODUCT CODIFICATION

<p>SPS</p> <p>↓</p> <p>Sonitron Polymer/metal Speaker</p>	<p>2220-03 3530-03 4640-03 6555-03 8770-03</p>	<p>C1 or C2</p> <p>↓</p> <p>C1: Position of solder pads C2: Position of solder pads</p>	
-------------------------------------------------------------------	----------------------------------------------------------------	---------------------------------------------------------------------------------------------	--

## LIST OF AVAILABLE PRODUCT TYPES

SPS-2220-03	SPS-3530-03-C1 SPS-3530-03-C2	SPS-4640-03-C1 SPS-4640-03-C2	SPS-6555-03-C1 SPS-6555-03-C2	SPS-8770-03-C1 SPS-8770-03-C2
-------------	----------------------------------	----------------------------------	----------------------------------	----------------------------------

## PACKAGING

The SPS-2220-03/3530-03/4640-03/6555-03/8770-03 are packed in trays (245 L x 245 W) and sold in boxes with dimensions of 250 L x 250 W x 125 H.

Number	SPS-2220-03	SPS-3530-03	SPS-4640-03	SPS-6555-03	SPS-8770-03
per tray	81	25	16	9	6
per box	(81x70) 5670	(25x40) 1000	(16x40) 640	(9x40) 360	(6x40) 240

Dimensions of the tray and position of the SPS-speakers 2022-03/3035-03/4640-03/8770-03/SPS-27-01 are illustrated below:

SPS-2220-03	A=1.5 mm B=26 mm C=26 mm
SPS-3530-03	A=3 mm B=47.5 mm C=47.5 mm
SPS-4640-03	A=3 mm B=60 mm C=60 mm
SPS-6555-03	A= 3mm B=68.5mm C=75.5mm
SPS-8770-03	A=3 mm B=78 mm C=120 mm

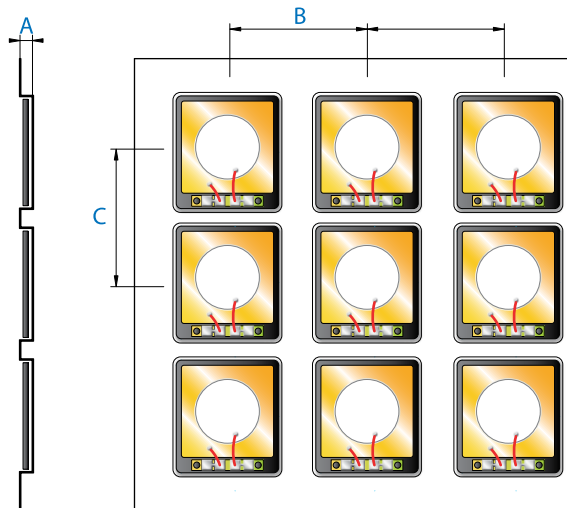

## ACOUSTIC MOUNTING INSTRUCTIONS FOR SPS-SPEAKERS

- Fundamental mounting recommendations see page 110.
- The SPS speakers can be mounted in several different ways. The mounting methods, illustrated below, are recommended to mount all the SPS speaker models. Please keep in mind that not too much mechanical stress is placed on the frame of the piezoceramic speaker after mounting.

**Mounted with glue or silicone**

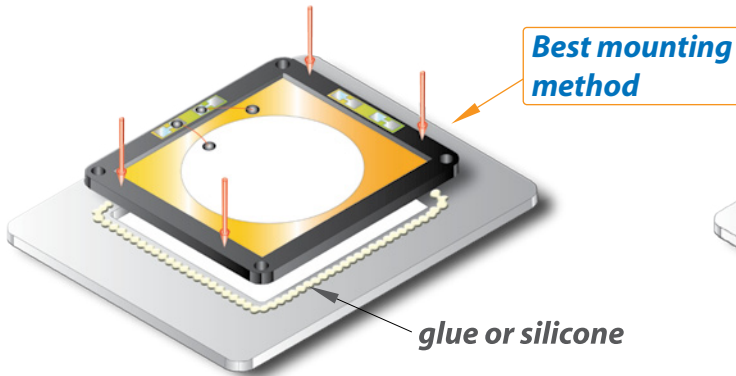

**Mounted with slot groove**



**Mounted with screws**

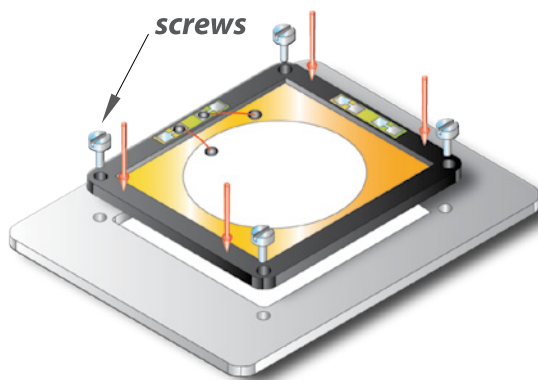

**Plastic deformation method (Ultrasonic)**

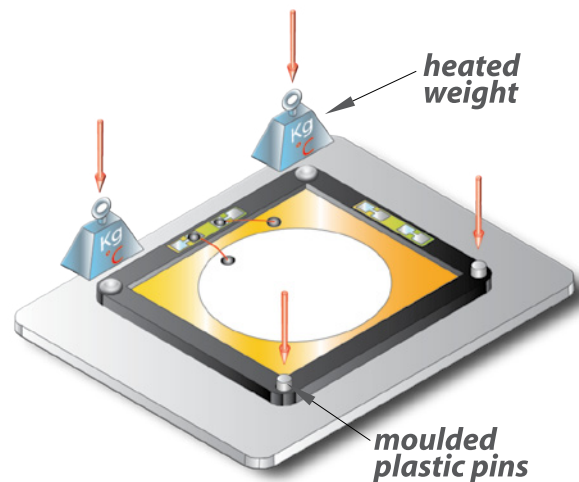

**Other methods...**

**Speaker cloth fabric**

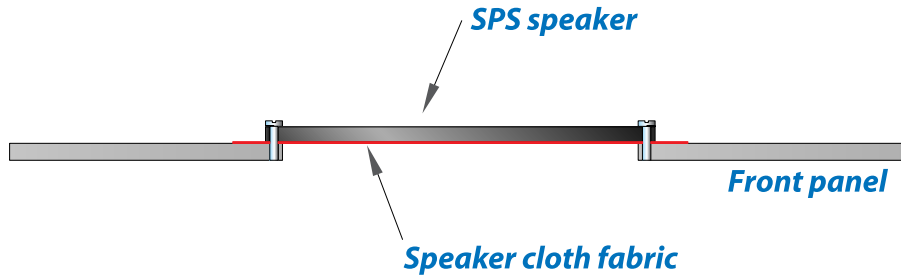

**Front holes**

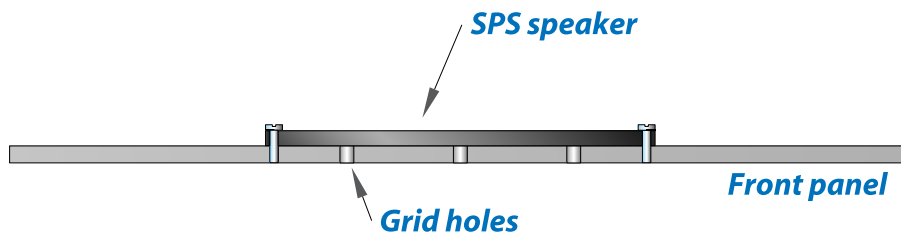

Front holes of      1 mm Ø for model SPS-2220-03  
                              2 mm Ø for model SPS-3530-03  
                              2 mm Ø for model SPS-4640-03  
                              2 mm Ø for model SPS-8770-03

Distance front holes    d=3 mm for model SPS-2220-03  
                                   d=5 mm for model SPS-3530-03  
                                   d=5 mm for model SPS-4640-03  
                                   d=10 mm for model SPS-S8770-03

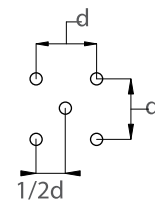

\*Other designs of the hole pattern (grids) are also suitable. (SPS-2220-03, SPS-3530-03)

grid examples



## FUNDAMENTAL ACOUSTIC MOUNTING RECOMMENDATIONS

Important note:

Piezoceramic speakers produce sound by the forward and backward movement of a flat membrane. During this movement the membrane creates an air pressure wave in front and at the backside of the membrane. A forward movement will create a slight overpressure at the frontside and a slight underpressure at the backside and vice versa. It is therefore important that the front and backside are acoustically isolated from each other to avoid air pressure cancellation and consequently a serious reduction of the sound output.

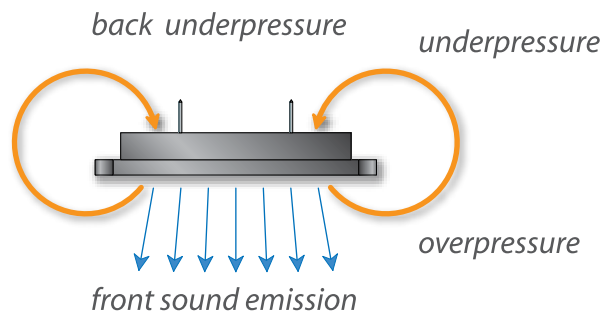

When a speaker is mounted in a panel or in the wall of a housing, the front side is acoustically isolated from the backside.

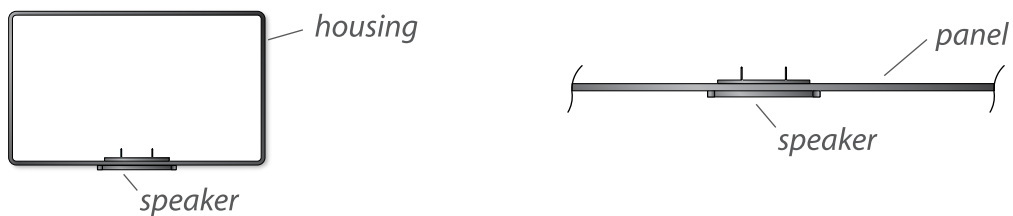

**BLUE LINE SPS SERIES** (Sonitron Polymer/metal Speakers)

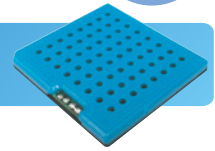

**SPS-29/41/53/68-T00 Piezoceramic Audio Speaker**

- louder ✓
- broad frequency range ✓
- fast and easy mountable ✓
- flat and solid construction ✓
- dust, water-and shockproof ✓
- very small current consumption ✓

Blue Line SPS series

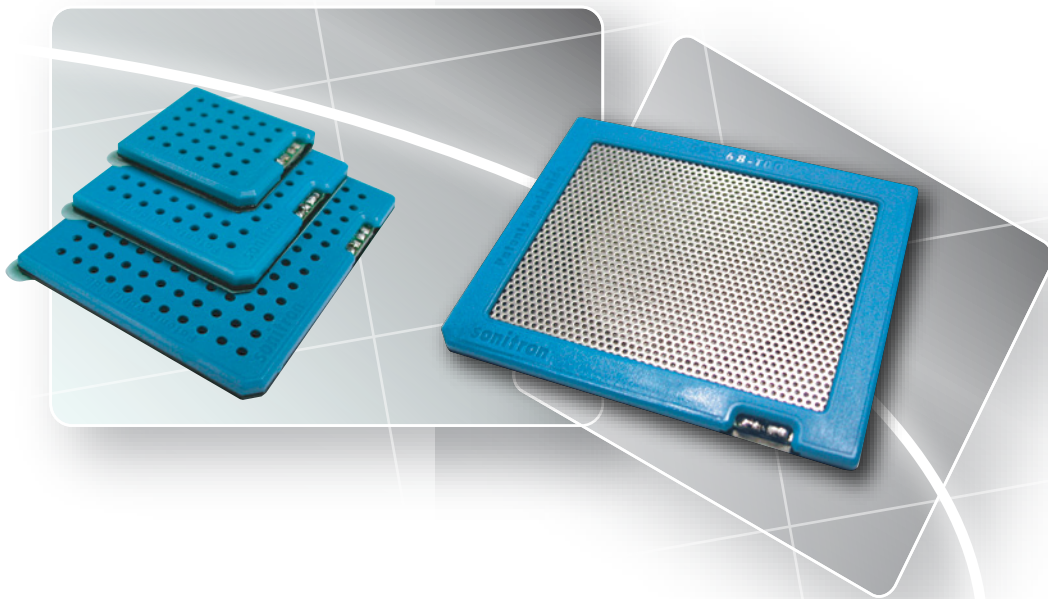

## INTRODUCTION

The **Blue line SPS Piezoceramic speaker series** are designed for a broad range of applications.

Equipped with a high power adhesive tape and soldering connection pads the speaker is ready for easy mounting and fast production in every application.

These series are reproducing sound signals at very low distortion (below 1%) and broad frequency range. The casing is designed to avoid sound wave reflection in the air outlet.

The power consumption and current drain are extremely low over the entire frequency response range.

Patented technology guarantees a slim line free form factor.



## ADVANTAGES & APPLICATIONS

### ADVANTAGES :

- very flat and solid construction
- dust, water- and shockproof
- resistant to temperature variations
- broad frequency range in small size
- combined use as speaker/micro
- no electro-magnetic field (EMC)
- little energy required at low frequencies
- less current consumption needed in the leads to the speaker
- 60% higher acoustic output for smaller speakers compared to electrodynamic speakers
- low weight
- low distortion
- high impedance
- can be driven directly by IC

### APPLICATIONS :

- GSM, GPS, PDA
- home equipment & domotics
- communication equipment
- talking buzzer & door bell
- computer equipment
- cars, busses and trains
- vending machines
- multimedia equipment
- industrial equipment
- portable voice recorders
- paging systems
- public address systems
- instrumentation
- cellular phone
- car audio system

## SPECIFICATIONS *(Transducer)*

Model	SPS-29-T00	SPS-41-T00	SPS-53-T00	SPS-68-T00
Frequency Range :	1KHz - 20 kHz	450Hz - 20 kHz	300Hz - 20 kHz	250Hz - 20 kHz
Max SPL @ 10 cm, 60 Vpp:	86 dB	90 dB	93 dB	93 dB
Distortion (%THD):	≤1%	≤1%	≤1%	≤1%
Capacitance (+/- 20%):	480 nF	880 nF	960 nF	1160 nF
Max. voltage PP, sine wave/RMS:	60Vpp/21.21(V <sub>RMS</sub> )	60Vpp/21.21(V <sub>RMS</sub> )	60Vpp/21.21(V <sub>RMS</sub> )	60Vpp/21.21(V <sub>RMS</sub> )
Weight:	3.1g	5.7g	10.1g	21 g
Operating Temperature:	-20°C to 60°C	-20°C to 60°C	-20°C to 60°C	-20°C to 60°C
Storage Temperature:	-40°C to 60°C	-40°C to 60°C	-40°C to 60°C	-40°C to 60°C
Case material:	PC	PC	PC	PC + RVS grid

## POWER CONSUMPTION

The average power consumption of the new SPS-series can be calculated by multiplying the RMS-voltage and RMS-current.

The **RMS-voltage** ( $V_{RMS}$ ) is defined by the input signal. The used signal is a standard pink noise signal with a value of  $10,6/21,21 V_{RMS}$ . This signal has the same energy as a sine wave of  $30/60V_{pp}$ .

Pink noise is an electronic signal that carries equal energy in all octaves (or similar log bundles) over the complete audio frequency range.

The **RMS-current** ( $I_{RMS}$ ) is measured with a true rms multimeter (Fluke 87V) in series with the speaker. A piezo speaker can mainly be seen as a capacitive load and therefore there will be no DC-current consumption. The only current consumption will be of the AC-current component.

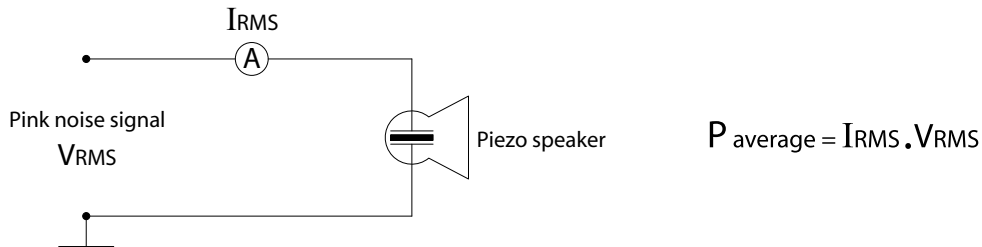

Model	10.6 $V_{RMS}$ (30 Vpp sine) $I_{RMS}=mA$	21.21 $V_{RMS}$ (60 Vpp sine) $I_{RMS}=mA$
SPS-29-T00	0,25Watt (= 24mA.10,6V)	1,00 Watt (= 47mA.21,21V)
SPS-41-T00	0,48 Watt (= 45mA.10,6V)	1,87 Watt (= 88mA.21,21V)
SPS-53-T00	0,78 Watt (= 74mA.10,6V)	3,05 Watt (= 144mA.21,21V)
SPS-68-T00	1.38 Watt (= 130mA.10,6V)	5.51 Watt (= 260mA.21,21V)

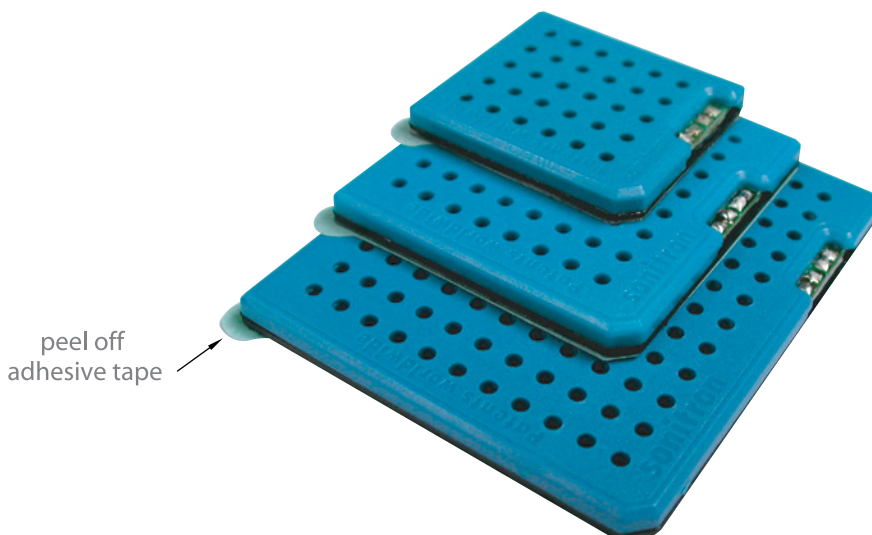

# FREQUENCY RESPONSE

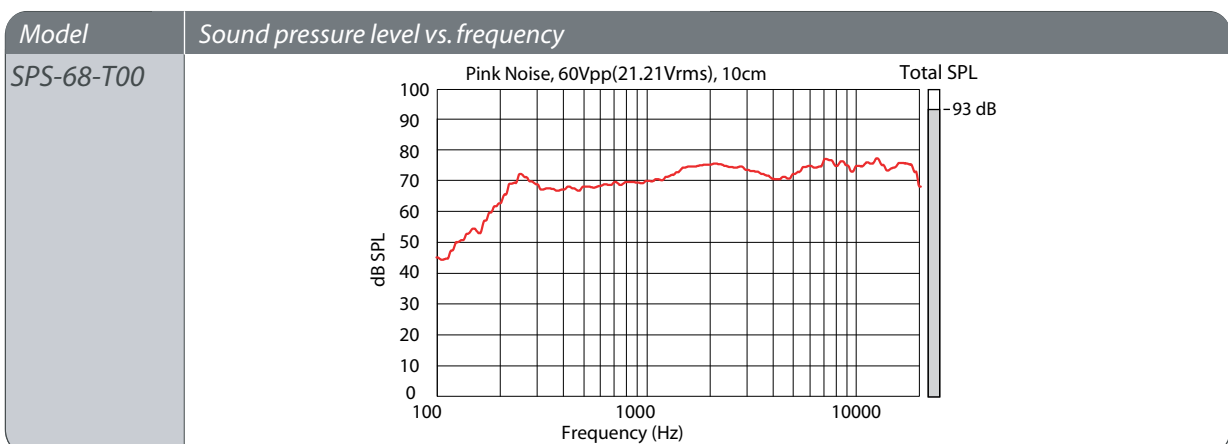
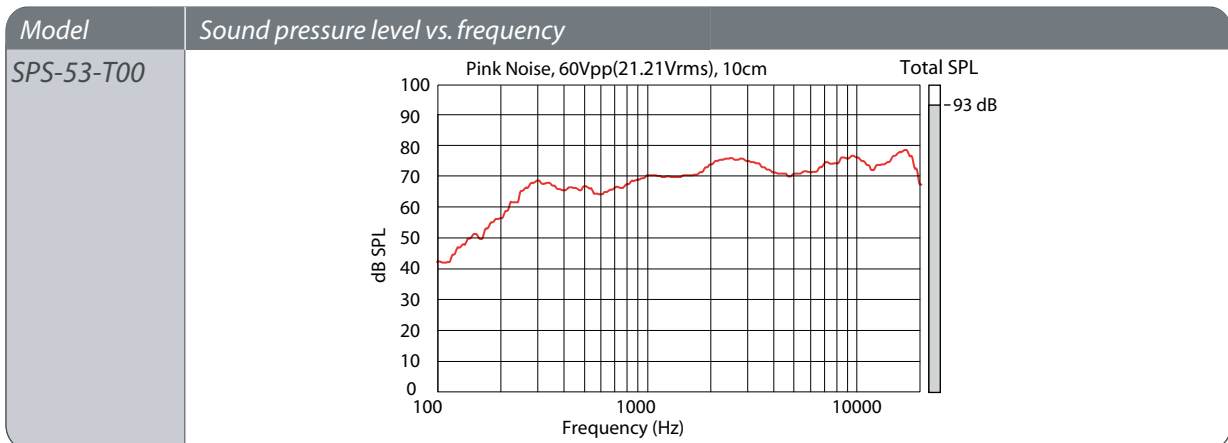
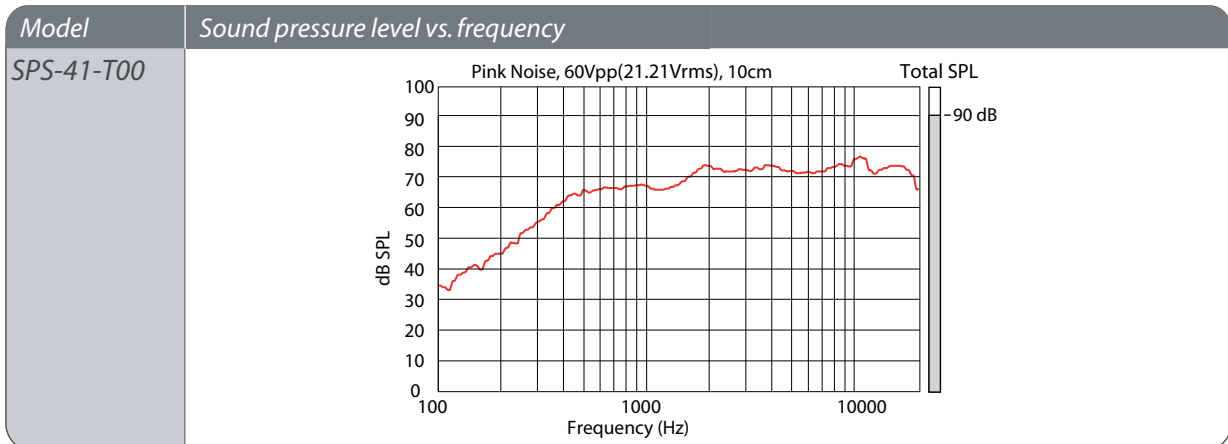
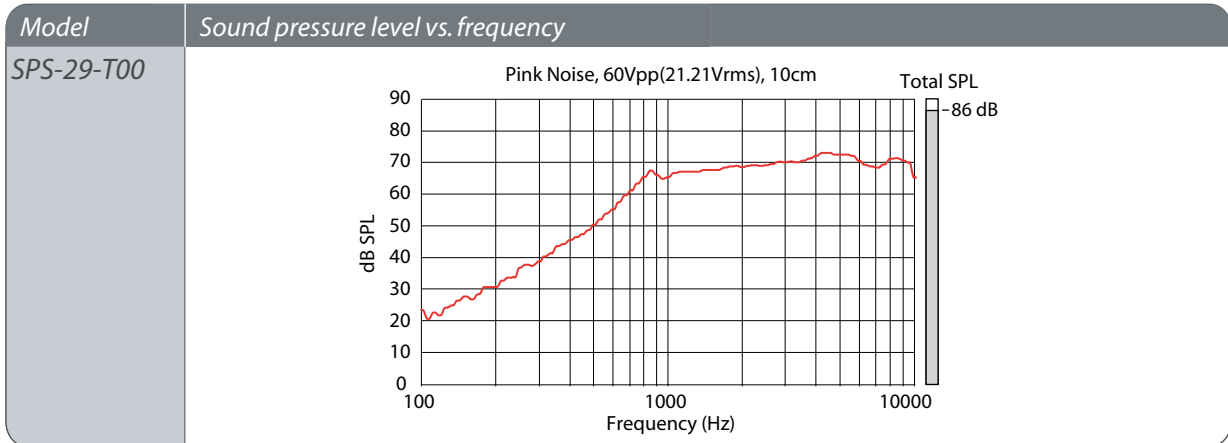



# DIMENSIONS

**SPS-29-T00**

4.5  
29.0  
32.0  
adhesive tape  
solder pads  
Patents worldwide  
sonitron  
A Blue speaker backside for easy production handling

Scale: 1:1

**SPS-41-T00**

4.5  
43.5  
41.0  
adhesive tape  
solder pads  
Patents worldwide  
sonitron

Scale: 1:1

**SPS-53-T00**

4.5  
61.2  
53.0  
adhesive tape  
solder pads  
Patents worldwide  
sonitron

Scale: 1:1

# DIMENSIONS

SPS-68-T00

Scale:  
1:1

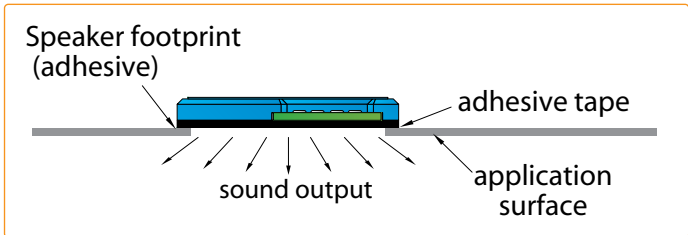
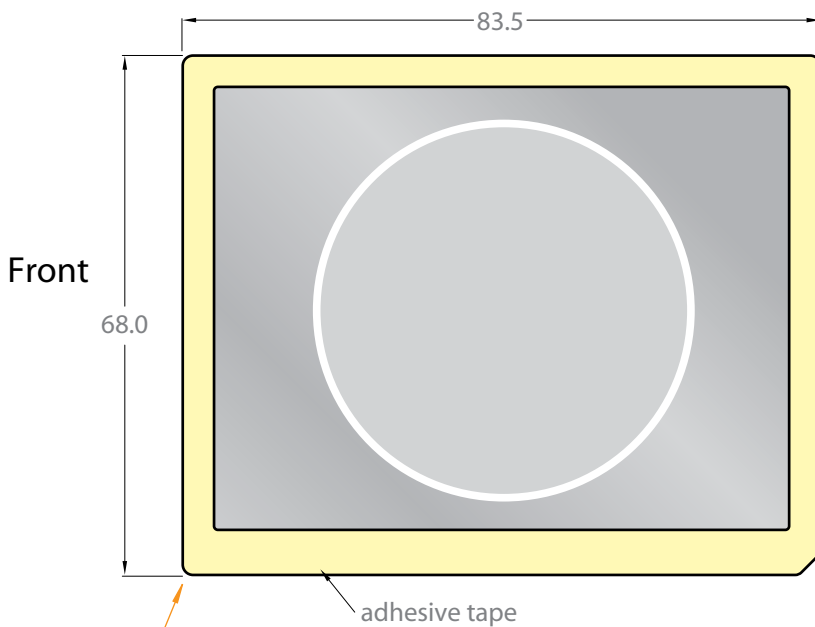
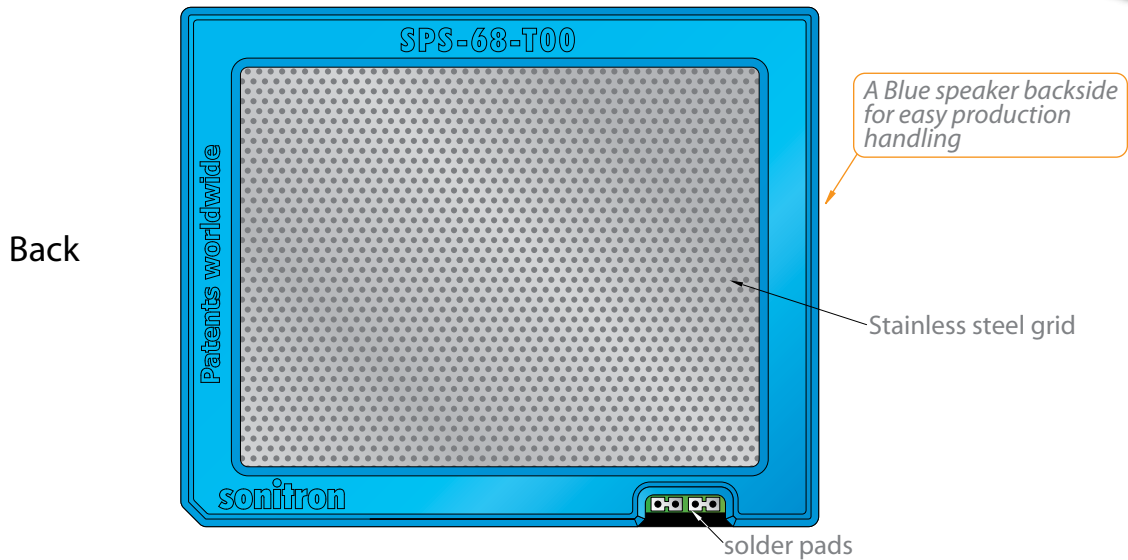
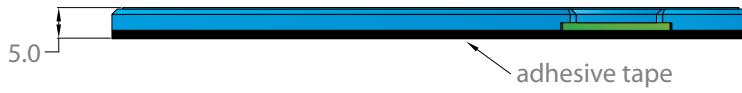

# MOUNTING GUIDELINES

peel-off adhesive tape

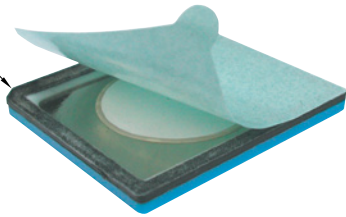

Speaker footprint (adhesive)

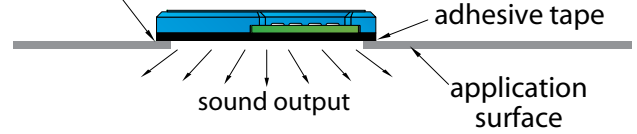

on request the speaker can be delivered without adhesive tape

**Important:** speaker grill cloth fabric, foam or other filters can be placed in front of the speaker to specifically "design" the desired sound output.

## Speaker (adhesive) footprint

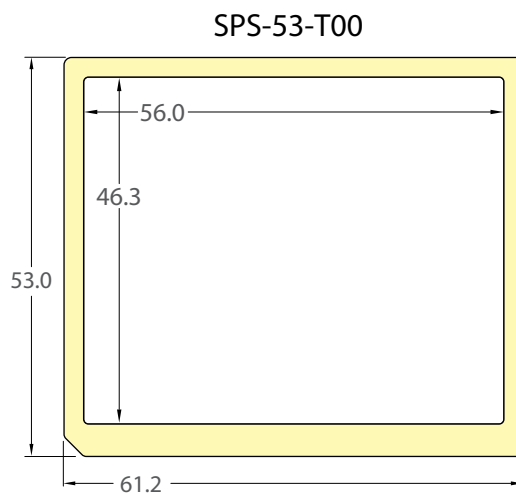
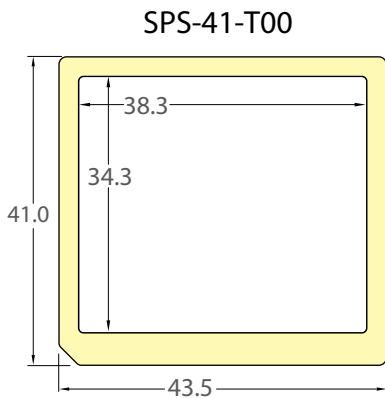
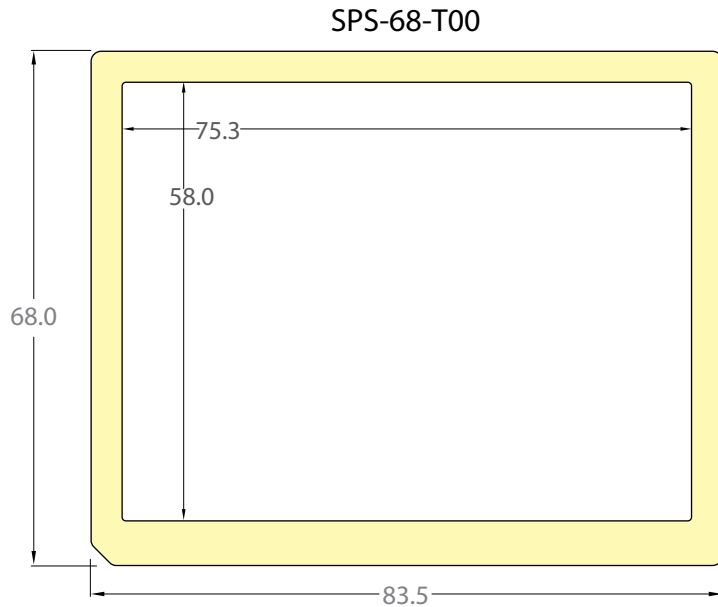
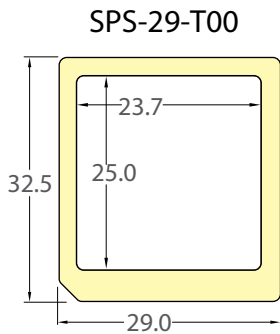

## PRODUCT OPTIONS

### Option FI (Front Installed) & FS (Front Seperate)

Optional a front panel is available, it is also equipped with adhesive tape for fast assembly to the application. It can be ordered pre-installed (already attached to the speaker) or as a separate part. (Be aware the speaker thickness increases with 1.5 mm.)

FI & FS option available for the following items:

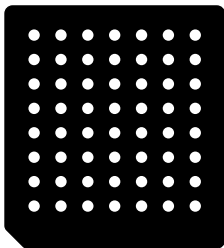

SPS-29-T00  
FRONT PANEL

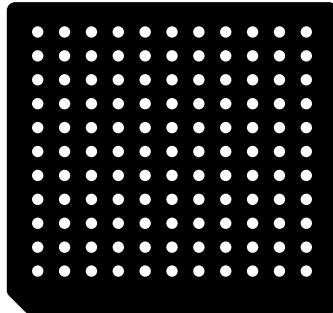

SPS-41-T00  
FRONT PANEL

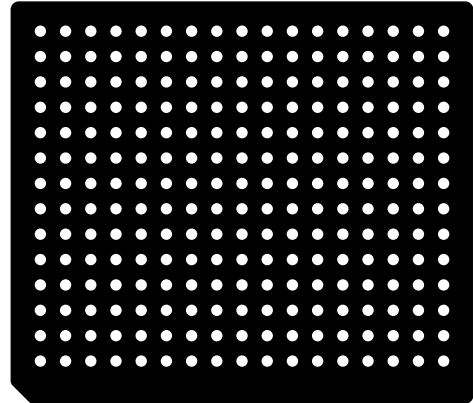

SPS-53-T00  
FRONT PANEL

Construction example:

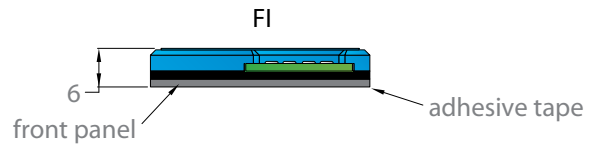
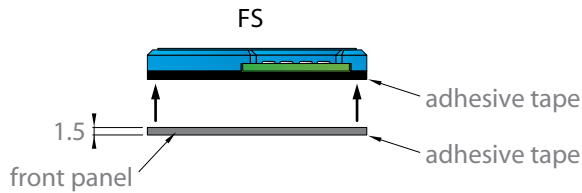

To order the speaker with pre-installed front panel add FI to the speaker codification (example: SPS-29-T00-**FI**)

To order the speaker with separate front panel add FS to the speaker codification (example: SPS-29-T00-**FS**)



## PRODUCT CODIFICATION

SPS -	29 -	T	00 -	F I -	F S
↓	41	↓	↓	↓	↓
53	↓	↓	↓	↓	↓
68*	Size	Transducer	Version	Front Installed	Front Separate
Sonitron Polymer/metal Speaker					

\*The SPS-68-T00 is always delivered without front. (standard with adhesive tape)

## LIST OF AVAILABLE PRODUCT TYPES

Standard	Optional	Optional
SPS-29-T00	SPS-29-T00-FI	SPS-29-T00-FS
SPS-41-T00	SPS-41-T00-FI	SPS-41-T00-FS
SPS-53-T00	SPS-53-T00-FI	SPS-53-T00-FS
SPS-68-T00	Not available	Not available

## PACKAGING

The SPS-29-T00/41-T00/53-T00/68-T00 are packed in trays (245 L x 245 W) and sold in boxes with dimensions of 250 L x 250 W x 125 H.

Model	SPS-29-T00	SPS-41-T00	SPS-53-T00	SPS-68-T00
per tray	30	16	9	6

Dimensions of the tray and position of the SPS-speakers SPS-29-T00/41-T00 and 53-T00 are illustrated below.

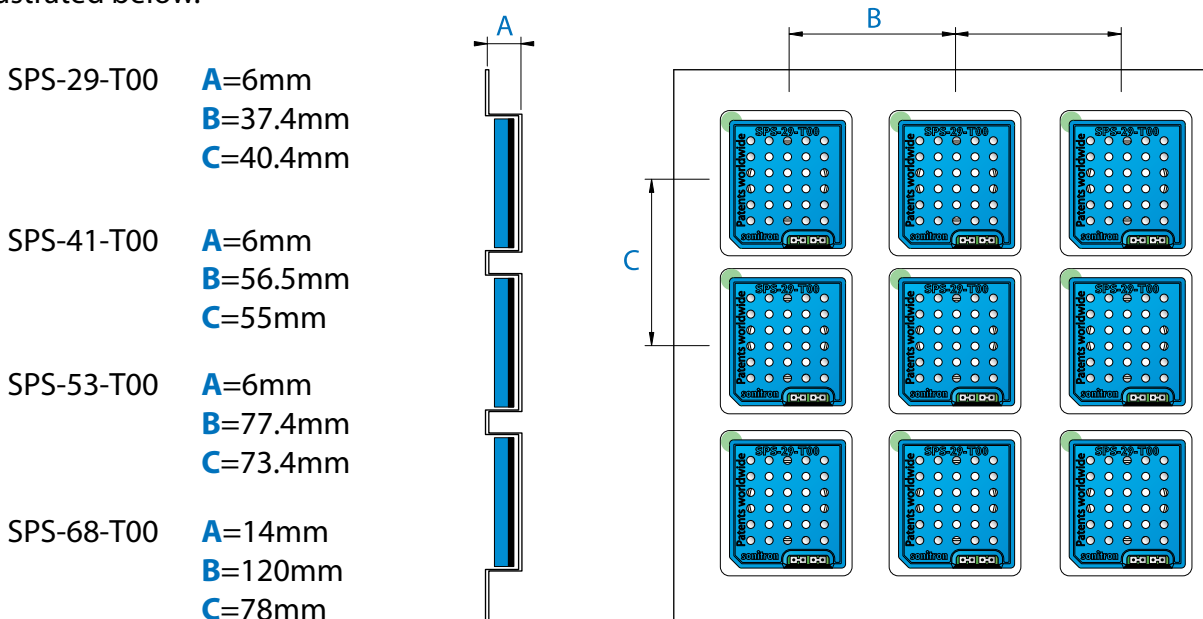

## RECOMMENDED PIEZO AUDIO AMPLIFIERS

### Integrated Circuits

**Maxim**  
MAX9788

**National semiconductor**  
LM4960

**Texas Instruments**  
TPA2100P1

### Sonitron production models

20Vpp amplifier

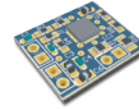

**PAA-MAX-9788-01**

24Vpp amplifier

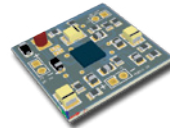

**PAA-LM4960SQ-02**

60Vpp amplifier

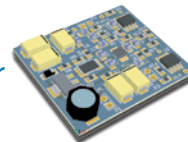

**PAA-StepUpBTL-01**

For more information about PAA-amplifiers, go to "PAA application documents" on our website.

## AVAILABLE DEMO-UNIT AND SAMPLE-KIT



### DU6597 & DU65SB

The demonstration unit DU6597 or DU65SB is the ideal way to have a first introduction to piezoceramic audio speaker technology.

### PAA Sample kit

The PAA Sample kit gives you the freedom to do experiments with a piezoceramic audio speaker SPS-6555-03 and four different piezo audio amplifiers. The SPS-6555-03 piezo speaker is built-in a small case for optimum sound quality.

PAA amplifiers:

- PAA-LT3469-01
- PAA-MAX9788-01
- PAA-LM4960SQ-02
- PAA-StepUpBTL-01



# PIEZO AUDIO AMPLIFIERS

PAA series

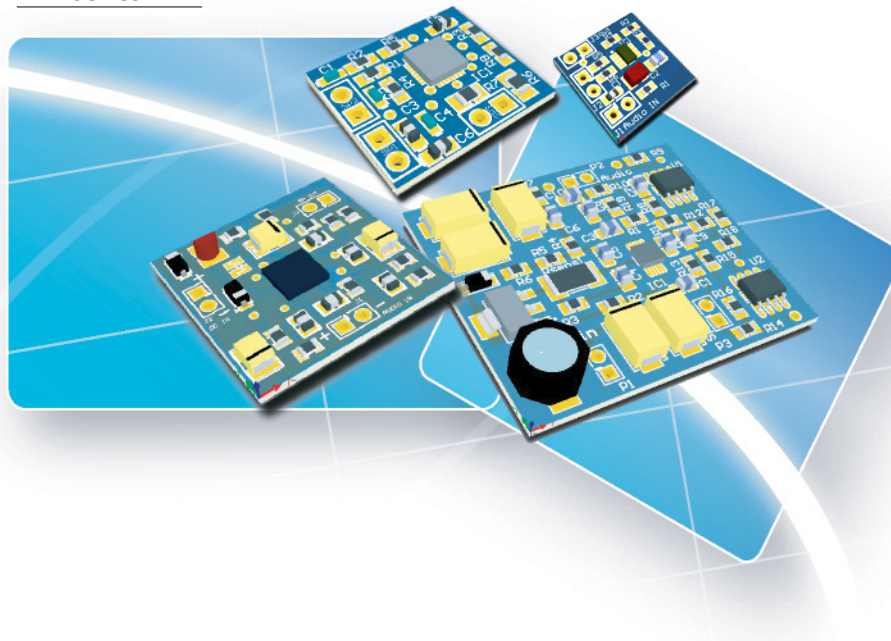

*In parallel with the amplifiers developed at Sonitron we refer to various integrated circuits available on the market.*

## PIEZO AUDIO AMPLIFIERS

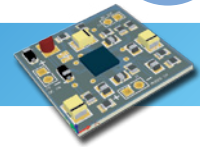

### INTRODUCTION

The **P**iezo **A**udio **A**mplifiers-series are a total solution to drive piezoceramic sound components. A range of different PCB sizes, amplifier topologies and maximum voltage peak to peak outputs, cover a wide solution to piezo audio amplification.

Piezo audio amplifiers are designed to handle capacitive loads and have the possibility to deliver large voltages peak to peak over the complete audio frequency range.

The heart of a piezo audio component is a ceramic piezo stone that interacts when it feels a certain voltage difference. An increase of a voltage peak to peak will have a larger piezo deformation and results in a larger sound output.

The PAA-series give a quality amplifier solution where a quality sound is needed.

### GENERAL OVERVIEW PAA SERIES

Model	PAA-LT3469-01	PAA-MAX9788-01	PAA-LM4960-02	PAA-StepUpBTL-01
Measurements PCB(mm)	15x15mm	14x16.5mm	25x25mm	40x35mm
Voltage input (V)	5V	5V	5V	5V-25V
MAX Capacitance Piezo Speaker	200nF	1µF	600nF	1µF
Max Voltage Output Vpp	33Vpp	20Vpp	24Vpp	60Vpp
Voltage Topology	Integrated step Up converter	Integrated step up converter	Integrated step up converter	Step up converter
Amplifier classification	Class A	Class G	Class AB	Class AB
Used amplifier configuration	Single ended	Fully Differential	Bridge Tied Load	Bridge Tied Load
Average current consumption of speaker and amplifier (mA)	45mA	15mA	85mA	40mA-400mA (2 Watt)

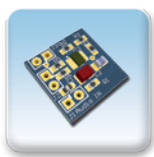

**PAA-LT3469-01**

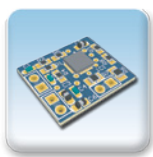

**PAA-MAX9788-01**

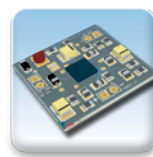

**PAA-LM4960SQ-02**

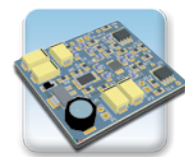

**PAA-StepUpBTL-01**



## BASICS OF PIEZO AUDIO AMPLIFIERS

$$PAA = P_{\text{iezo}} A_{\text{udio}} A_{\text{mplifier}}$$

An amplifier for audio signals special designed to drive capacitive loads.

**Max Cap.:** The maximum capacitance the Piezo Audio amplifier can handle.

-*Load Capacitance:* The main impedance of the Piezo Speaker or Piezo vibration element is a capacitance with values mostly between 10nF and 1µF.

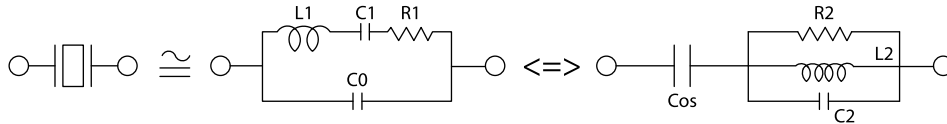

Simple Equivalent electronic circuits of a piezo element:

**Max Vpp:** Maximum voltage peak to peak that an amplifier can deliver at his output channel.

-*Max speaker Vpp:* Maximum voltage swing a piezo speaker can handle to work correctly within the described life time.

-*The heart of a Piezo speaker* is the piezo ceramic stone that interacts with voltage differences. How larger the voltage difference how more intense the amplitude of the sound will be.

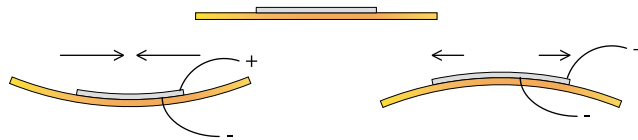

## PIEZO AUDIO AMPLIFIER SERIES

### PAA-LT3469-01

A PCB of only 2.25cm<sup>2</sup>. The LT3469 is a very small signal amplifier up to 30Vpp.

- Integrated charge pump power supply
- Class A Amplifier
- Single ended
- Capacitive load up to 250nF
- 10 components

total thickness:  
2.7 mm

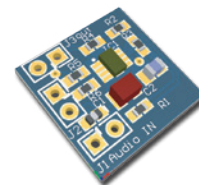
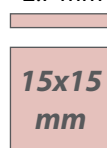

Fixed amplification ratio: +/- 131  
Voltage input: 5 V

### PAA-MAX9788-01

Designed on a printed circuits board of only 2,31 cm<sup>2</sup>, the "Max9788" piezo audio amplifier of Maxim fulfils the needs of very small designs in portable applications. A maximum output of 20Vpp and very low power consumption makes it even more attractive.

- Integrated charge pump power supply
- Class G Amplifier
- Fully differential inputs and outputs
- Capacitive load up to 1µF
- 15 components

total thickness:  
1.88 mm

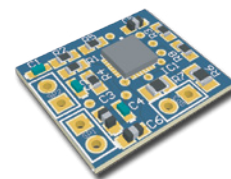
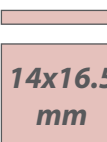

Fixed amplification ratio: +/- 80  
Voltage input: 5 V

## PAA-LM4960SQ-02

A perfect balance of a bridge tied load and step up converter on a small PCB, the "LM4960" IC of National Semiconductor reaches 24 Vpp for a load of 600nF. Small design and great sound output makes it very understandable.

- Integrated Step Up Converter
- Bridge tied load
- Very small inductor
- Up to 24Vpp
- 22 components

total thickness:  
4.25 mm

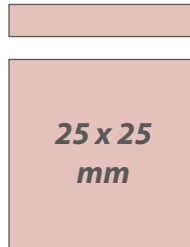

actual size

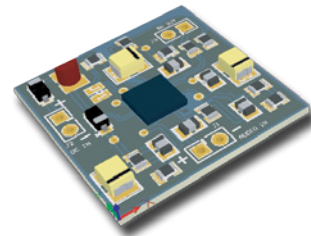

Fixed amplification ratio: +/- 74  
Voltage input: 5 V

## PAA-StepUpBTL-01

To go loud is to amplify the input signal to a large Voltage peak to peak swing of maximum 60Vpp. Tuned on the SPS piezo speakers the "StepUpBTL" piezo audio amplifier is designed for a very loud audio sound in a room.

The creation of a 60Vpp swing derives from a stable DC power source of 30 V DC.

The boostconverter circuit is designed to a minimum surface with a maximum variety at the input source. A variation of the input voltage between 5V and 25V gives at the end a stable 30VDC to power the opamps with efficient power consumption.

The amplifier circuit is a perfect balance between power consumption and space design. The Bridge Tied Load amplifier topology makes it possible to swing the signal to 60Vpp.

- Input voltage 5V-25V
- Max. output 60Vpp
- Two electronic circuits
- **Ideal: +input: 9Vdc**  
**+output: 40Vpp**

total thickness:  
6 mm

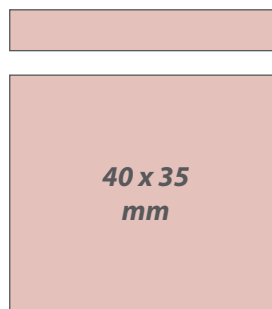

actual size

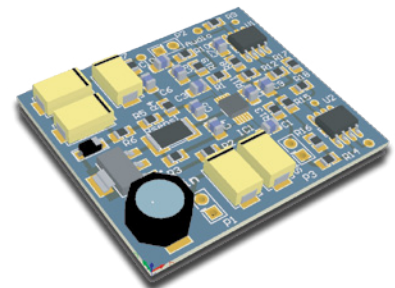

Fixed amplification ratio: +/- 90  
Voltage input: 5-25 V

### Boost converter + Amplifier

- DC-DC- converter: Max 669  
=> output: 30 Vdc
- Amplifier circuit: OPA 551  
=>"Bridge tied load configuration"